HP 3235 Switch/Test Unit

**HP 3235
Installation Manual**



Copyright © Hewlett-Packard Company, 1986
Loveland Instrument Division
P. O. Box 301, Loveland, Colorado 80539

Manual Part Number: 03235-90004
Microfiche Part Number: 03235-99004

Printed: AUGUST 1986 Edition 1
Printed in U.S.A. E886



Herstellerbescheinigung

Hiermit wird bescheinigt, daß das Gerät/System HP 3235
in Übereinstimmung mit den Bestimmungen von Postverfügung 1046/84 funkentstört ist.

Der Deutschen Bundespost wurde das Inverkehrbringen dieses Gerätes/Systems angezeigt und die Berechtigung zur Überprüfung der Serie auf Einhaltung der Bestimmungen eingeräumt.

Zusatzinformation für Meß- und Testgeräte

Werden Meß- und Testgeräte mit ungeschirmten Kabeln und/oder in offenen Meßaufbauten verwendet, so ist vom Betreiber sicherzustellen, daß die Funk-Entstörbestimmungen unter Betriebsbedingungen an seiner Grundstücksgrenze eingehalten werden.

Manufacturer's declaration

This is to certify that the equipment HP 3235
is in accordance with the Radio Interference Requirements of Directive FTZ 1046/84. The German Bundespost was notified that this equipment was put into circulation, the right to check the series for compliance with the requirements was granted.

Additional Information for Test- and Measurement Equipment

If Test- and Measurement Equipment is operated with unscreened cables and/or used for measurements on open set-ups, the user has to assure that under operating conditions the Radio Interference Limits are still met at the border of his premises.

NOTICE

The information contained in this document is subject to change without notice.

HEWLETT-PACKARD MAKES NO WARRANTY OF ANY KIND WITH REGARD TO THIS MATERIAL, INCLUDING, BUT NOT LIMITED TO, THE IMPLIED WARRANTIES OF MERCHANTABILITY AND FITNESS FOR A PARTICULAR PURPOSE. Hewlett-Packard shall not be liable for errors contained herein or for incidental or consequential damages in connection with the furnishing, performance or use of this material.

Hewlett-Packard assumes no responsibility for the use or reliability of its software on equipment that is not furnished by Hewlett-Packard.

This document contains proprietary information which is protected by copyright. All rights are reserved. No part of this document may be photocopied, reproduced or translated to another language without the prior written consent of Hewlett-Packard Company.



CERTIFICATION

Hewlett-Packard Company certifies that this product met its published specifications at the time of shipment from the factory. Hewlett-Packard further certifies that its calibration measurements are traceable to the United States National Bureau of Standards, to the extent allowed by the Bureau's calibration facility, and to the calibration facilities of other International Standards Organization members.

WARRANTY

This Hewlett-Packard instrument product is warranted against defects in materials and workmanship for a period of one year from date of shipment. During the warranty period, Hewlett-Packard Company will, at its option, either repair or replace products which prove to be defective.

For warranty service or repair, this product must be returned to a service facility designated by -hp-. Buyer shall prepay shipping charges to -hp- and -hp- shall pay shipping charges to return the product to Buyer. However, Buyer shall pay all shipping charges, duties, and taxes for products returned to -hp- from another country.

Duration and conditions of warranty for this instrument may be superceded when the instrument is integrated into (becomes a part of) other -hp- instrument products.

Hewlett-Packard warrants that its software and firmware designated by -hp- for use with an instrument will execute its programming instructions when properly installed on that instrument. Hewlett-Packard does not warrant that the operation of the instrument, or software, or firmware will be uninterrupted or error free.

LIMITATION OF WARRANTY

The foregoing warranty shall not apply to defects resulting from improper or inadequate maintenance by Buyer, Buyer-supplied software or interfacing, unauthorized modification or misuse, operation outside of the environmental specifications for the product, or improper site preparation or maintenance.

NO OTHER WARRANTY IS EXPRESSED OR IMPLIED. HEWLETT-PACKARD SPECIFICALLY DISCLAIMS THE IMPLIED WARRANTIES OF MERCHANTABILITY AND FITNESS FOR A PARTICULAR PURPOSE.

EXCLUSIVE REMEDIES

THE REMEDIES PROVIDED HEREIN ARE BUYER'S SOLE AND EXCLUSIVE REMEDIES. HEWLETT-PACKARD SHALL NOT BE LIABLE FOR ANY DIRECT, INDIRECT, SPECIAL, INCIDENTAL, OR CONSEQUENTIAL DAMAGES, WHETHER BASED ON CONTRACT, TORT, OR ANY OTHER LEGAL THEORY.

ASSISTANCE

Product maintenance agreements and other customer assistance agreements are available for Hewlett-Packard products.

For any assistance, contact your nearest Hewlett-Packard Sales and Service Office. Addresses are provided at the back of this manual.



**HEWLETT
PACKARD**

SAFETY SUMMARY

The following general safety precautions must be observed during all phases of operation, service, and repair of this instrument. Failure to comply with these precautions or with specific warnings elsewhere in this manual violates safety standards of design, manufacture, and intended use of the instrument. Hewlett-Packard Company assumes no liability for the customer's failure to comply with these requirements. This is a Safety Class 1 instrument.

GROUND THE INSTRUMENT

To minimize shock hazard, the instrument chassis and cabinet must be connected to an electrical ground. The instrument is equipped with a three-conductor ac power cable. The power cable must either be plugged into an approved three-contact electrical outlet or used with a three-contact to two-contact adapter with the grounding wire (green) firmly connected to an electrical ground (safety ground) at the power outlet. The power jack and mating plug of the power cable meet International Electrotechnical Commission (IEC) safety standards.

DO NOT OPERATE IN AN EXPLOSIVE ATMOSPHERE

Do not operate the instrument in the presence of flammable gases or fumes. Operation of any electrical instrument in such an environment constitutes a definite safety hazard.

KEEP AWAY FROM LIVE CIRCUITS

Operating personnel must not remove instrument covers. Component replacement and internal adjustments must be made by qualified maintenance personnel. Do not replace components with power cable connected. Under certain conditions, dangerous voltages may exist even with the power cable removed. To avoid injuries, always disconnect power and discharge circuits before touching them.

DO NOT SERVICE OR ADJUST ALONE

Do not attempt internal service or adjustment unless another person, capable of rendering first aid and resuscitation, is present.

DO NOT SUBSTITUTE PARTS OR MODIFY INSTRUMENT

Because of the danger of introducing additional hazards, do not install substitute parts or perform any unauthorized modification to the instrument. Return the instrument to a Hewlett-Packard Sales and Service Office for service and repair to ensure that safety features are maintained.

DO NOT OPERATE A DAMAGED INSTRUMENT

Whenever it is possible that the safety protection features built into this instrument have been impaired, either through physical damage, excessive moisture, or any other reason, REMOVE POWER and do not use the instrument until safe operation can be verified by service-trained personnel. If necessary, return the instrument to a Hewlett-Packard Sales and Service Office for service and repair to ensure that safety features are maintained.

DANGEROUS PROCEDURE WARNINGS

Warnings, such as the example below, precede potentially dangerous procedures throughout this manual. Instructions contained in the warnings must be followed.

WARNING

Dangerous voltages, capable of causing death, are present in this instrument. Use extreme caution when handling, testing, and adjusting.

Operating and Safety Symbols

Symbols Used On Products And In Manuals

~ LINE AC line voltage input receptacle.



Instruction manual symbol affixed to product. Cautions the user to refer to respective instruction manual procedures to avoid possible damage to the product.



Indicates dangerous voltage – terminals connected to interior voltage exceeding 1000 volts.

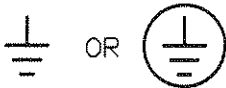

Protective conductor terminal. Indicates the field wiring terminal that must be connected to earth ground before operating equipment – protects against electrical shock in case of fault.



Clean ground (low-noise). Indicates terminal that must be connected to earth ground before operating equipment – for single common connections and protection against electrical shock in case of fault.

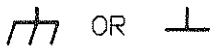

Frame or chassis ground. Indicates equipment chassis ground terminal – normally connects to equipment frame and all metal parts.



Affixed to product containing static sensitive devices – use anti-static handling procedures to prevent electrostatic discharge damage to components.

NOTE

NOTE

Calls attention to a procedure, practice, or condition that requires special attention by the reader.

CAUTION

CAUTION

Calls attention to a procedure, practice, or condition that could possibly cause damage to equipment or permanent loss of data.

WARNING

WARNING

Calls attention to a procedure, practice, or condition that could possibly cause bodily injury or death.







WARNING and CAUTION Symbols

The HP 3235 mainframe, extender frames, and the plug-in modules include subscripted international warning symbols (e.g. ). These warning symbols refer the user to the operating manuals for further information.

The table below shows the warning used on the HP 3235 and its plug-in modules.

HP 3235 Warnings

Symbol	Meaning	Where Used
	Hazardous voltage may be present when the Quick Interconnect Fixture is open.	The Quick Interconnect Fixture. See Chapter 2 for additional information.
	A shock hazard may exist. Turn off all power to the HP 3235 mainframe and extenders before installing or removing plug-in modules. Do not exceed 42V maximum.	HP 34504, 34505, and 34506 Plug-in Modules.
	A shock hazard may exist. Turn off all power to the HP 3235 mainframe and extenders before installing or removing plug-in modules.	HP 34501, 34502, 34503, 34507, 34520, and 34522 Plug-in Modules.
	The sheet metal screws on the HP 34520 Multimeter are at guard potential.	HP 34522 Multimeter Module. See Chapter 2 for additional information on Guard.
	Do not carry the HP 3235 mainframe or extender frame by the Quick Interconnect mechanism handles.	Quick Interconnect Mechanism handles.

Contents

Installing the HP 3235

Introduction	1
Safety Items	2
CAUTION: Prevent QIF Mechanism Damage	2
CAUTION: Prevent Module Connector Breakage	3
STU Description.	4
Taking Inventory	6
Serial Number.	6
How to Obtain Repair Service	6
General Shipping Instructions.	6
Environmental Requirements	7
PART 1: Installation Required For HP 3235 User Training	8
Power Requirements.	8
Grounding Requirements	8
Power Cords and Receptacles.	9
Line Voltage Selection.	10
Install/Replace the Power Line Fuse	11
Setting the Frame Address.	12
HP-IB Interface	13
HP-IB Address Selection.	13
Control Panel Connection.	15
Applying Power	16
Power Fault Light.	16
Restoring Operation.	16
Installing the Plug-In Modules.	17
PART 2: Installation That Is Application Dependent.	20
Installing Extenders	21
Extender Power Requirements	21
Setting Extender Frame Addresses	21
Locating Extenders Near the Mainframe	21
Installing Analog Extender Cables.	23
Installing Digital Extender Cables.	26
Installing a Bus Access (or Extender Module).	27
Floating User Side Ground (GUARD)	29
Feedthrough Panels	30
BNC Feedthrough Panels	31
BNC Terminal Blocks.	31

Low-Frequency Feedthrough Panels	31
DIN Terminal Blocks	31
Routing Feedthrough Panel Cables or Wires	32
Connecting Cables or Wires to Feedthrough Panels	33
Installing Feedthrough Panels	35
Terminal Block Preparation	36
Installing ID Labels	36
Terminal Assignment Label	37
Installing Screw-Terminal Connector Labels	38
Removing Terminal Block Extractors	39
Terminal Block Styles	40
Terminal Blocks for BNC Plug-In Modules	41
Cable Terminal Block	41
Cabling the Cable Terminal Block	42
Bulkhead Terminal Block	43
Strain Relief	44
Terminal Blocks for DIN Plug-In Modules	45
Solder-Eye/Slide-On Terminal Block	45
Screw-Terminal Block	45
Strain Relief	46
Connecting Terminal Blocks to Modules	47
Installing the Quick Interconnect Fixture	48
Quick Interconnect Fixture	49
Installing Terminal Blocks	50
Installing Retainer Rods	50
Unlock QIF Mechanism Handles	51
Installing Loaded Fixture Onto Mounting Bars	51
Locking QIF to Mounting Bars	52
Engaging QIF and Locking Handles	52
Removing the QIF	53
Typical QIF Installation	53
Installing User-Built DUT Fixtures	54
Benchtop or Rack Mount?	57
Bench Operation	57
Standard Rack Mounting	57
Reverse Rack Mounting	57
Rack Slides	60
Installing the HP 34550A Control Panel	61
Benchtop Use	61
Rack Mount Slanted	61
Rack Mount Vertical	62
Miscellaneous	64
Trigger Bus	64
Connecting to the Interlock Switch	64
Installing the HP 34592A Wire Distribution Frame	65

List of Figures

Installing the HP 3235

Figure 1. CAUTION: Prevent QIF Mechanism Damage	2
Figure 2. CAUTION: Prevent Module Connector Breakage	3
Figure 3. HP 3235 System Side and User Side	4
Figure 4. Power Cords	9
Figure 5. Line Voltage Selection	10
Figure 6. Installing or Replacing the Power Line Fuse.	11
Figure 7. Setting the Frame Address	12
Figure 8. Typical HP-IB System Interconnection.	13
Figure 9. Control Panel Connection	15
Figure 10. Removing the User Side Panel.	18
Figure 11. Installing the Plug-In Modules.	19
Figure 12. Cable Length Restrictions	22
Figure 13. HP 34560 Extender Module	23
Figure 14. Removing Inner Screws of J1 and J2	25
Figure 15. Removing Outer Screws of J1 and J2	25
Figure 16. Analog Extender Cable Strain Relief	26
Figure 17. Bus Access and Extender Modules.	28
Figure 18. Bus Access or Extender Module Location.	28
Figure 19. Floating User Side Ground (GUARD).	29
Figure 20. Feedthrough Panels	30
Figure 21. Removing System-Side Access Cover	32
Figure 22. Removing Frame Left Side Panel	32
Figure 23. Removing Card Cage Front Panel.	33
Figure 24. Removing Card Cage Side Access Cover	33
Figure 25. Routing Cables or Wires to the Cage	34
Figure 26. Connecting Cables to BNC Feedthrough Panel	34
Figure 27. Connecting Wires to DIN Feedthrough Panel.	35
Figure 28. Labels Installed on Terminal Blocks.	36
Figure 29. Terminal Assignment Label	37
Figure 30. Installing Screw-Terminal Connector Labels.	38
Figure 31. Terminal Block Extractor Removal	39
Figure 32. Terminal Block Styles	40
Figure 33. Cable Terminal Block	41
Figure 34. Assembling Cable to BNC Connector	42
Figure 35. Bulkhead Terminal Block	43
Figure 36. Strain Relief Clamp - Cables.	44
Figure 37. Strain Relief Clamp - Wires	46
Figure 38. Connecting Terminal Blocks to Modules	47
Figure 39. QIF and Mechanism	48
Figure 40. Quick Interconnect Fixture	49
Figure 41. Installing Terminal Blocks	50
Figure 42. Installing Retainer Rods	50
Figure 43. Unlock QIF Mechanism Handles	51
Figure 44. Installing Loaded Fixture Onto Mounting Bars	51
Figure 45. Locking QIF to Mounting Bars	52
Figure 46. Engaging QIF and Locking Handles.	52
Figure 47. Typical HP 3235 Rack Installation With QIF	53
Figure 48. Typical User-Built Fixture on QIF.	54
Figure 49. Sheetmetal Layout for User-Built Fixture.	55/56
Figure 50. Remove Side Trim From Bezel	59

Figure 51. Reverse Rack Mount Flange Mounting Holes	59
Figure 52. Installing Sheetmetal Nuts and Hardware	60
Figure 53. Slanted Control Panel Rack Mount	62
Figure 54. Vertical Control Panel Rack Mount.	63
Figure 55. Interlock Contact Connector	64
Figure 56. Wire Distribution Frame.	65

List of Tables

Installing the HP 3235

Table 1. Materials Supplied	5
Table 2. Environmental Requirements	7
Table 3. Supplied Power Line Fuses and Fuse Caps.	11
Table 4. HP 3235 HP-IB Address Codes	14
Table 5. Reverse Rack Mount Kit Parts List	58

HP 3235 User Documentation Map

The HP 3235 documentation diagram shown below lists the user manuals available for the HP 3235. In addition to these manuals, a service manual is also available. Check with your local HP Sales and Service office for the current HP part numbers.

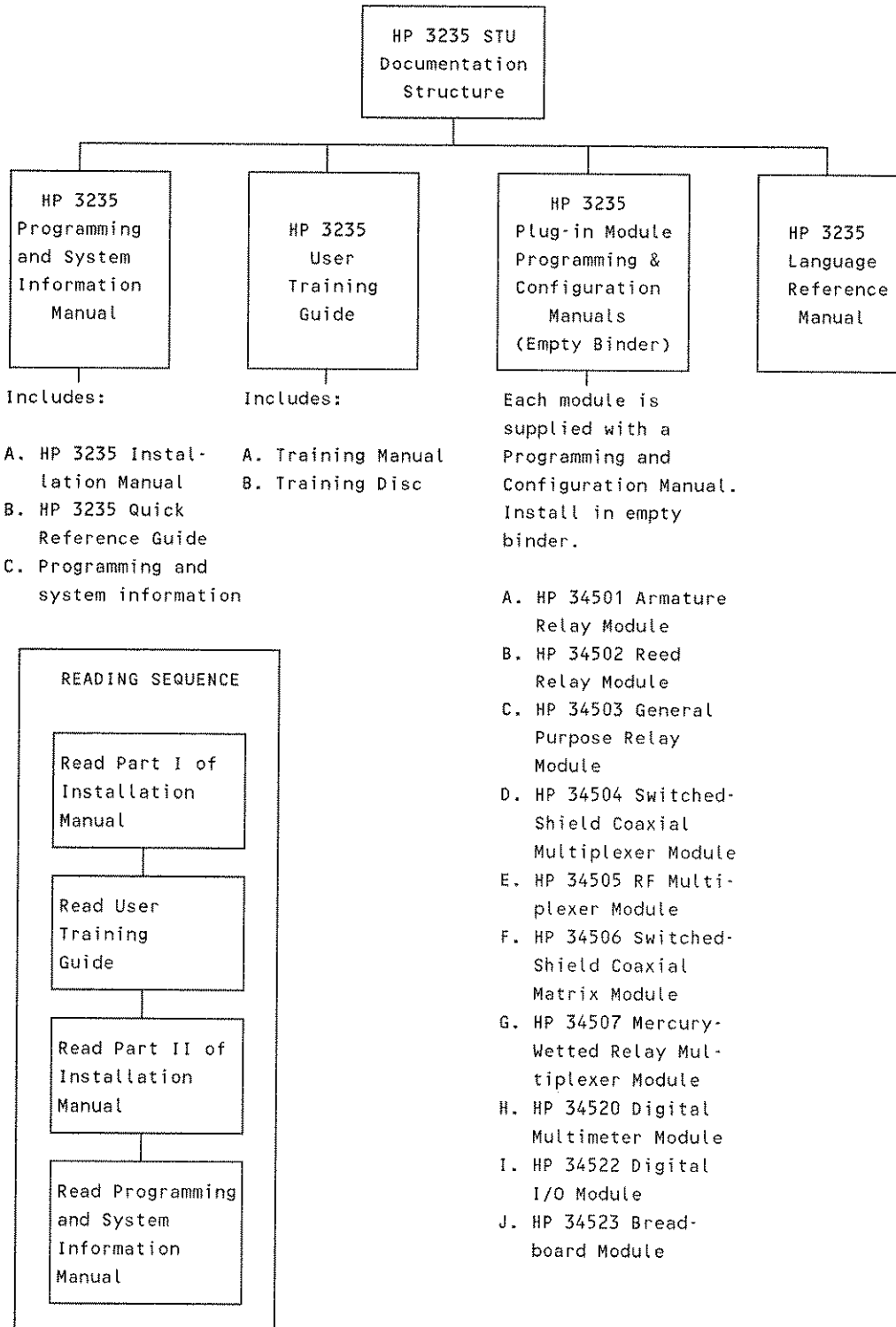



Installing the HP 3235

Introduction

This manual provides instructions for service-trained personnel to install the HP 3235 Switch/Test Unit (STU) and Switch/Test Unit Extenders. Installation is in two parts:

1. Procedures required to set-up the STU system and begin using the HP 3235 User Training Guide.
2. Procedures that are application dependent and follow initial set-up, training, and familiarization with the STU system.

Following is a summary of the procedures contained in each part:

Part 1. Installation procedures required to begin HP 3235 user training.

- Set the power requirements on the mainframe (line voltage, fuse, etc.).
NOTE: Extender frames are not required for training.
- Set the frame address to zero on the mainframe.
- Connect the HP-IB interface from mainframe to your system controller.
- Connect the optional control panel (if you have one) to the mainframe.
- Install plug-in modules in the mainframe and record the slot number they are installed in.
- Apply power to the mainframe.

After completing the installation procedures of Part 1, the system is now set up for you to begin the training lessons in the User Training Guide (HP P/N 03235-90006). When finished with the training lessons, you will have an understanding of the STU and plug-in module operation. At this time, you define the test requirement/STU system cabling and proceed with the installation procedures of Part 2.

Part 2. Installation procedures that are application dependent.

- Floating user side ground.
- Installing extender frames if part of the system.
- Installing a Bus Access module (mainframe only system).
- Installing Extender modules and digital extender cables (mainframe with extender frame system).
- Installing analog bus extender cables.
- Installing feedthrough panels.
- Terminal block preparation and connection of field wiring.
- Connecting terminal blocks to modules.
- Installing the optional quick interconnect fixture.
- Rack mounting mainframes or extenders.
- Rack mounting the optional control panel.

Safety Items

This manual contains cautions and warnings alerting the user to hazardous operating and maintenance conditions. Some cautions alert the user to conditions that can cause physical damage to the equipment when the mainframe, extenders, or modules are handled improperly. This information is flagged by a caution or warning heading and/or the symbol !. The ! symbol appears on equipment where the caution or warning applies. It is an international symbol meaning "refer to the operating manual". This symbol flags important operating or safety instructions. To ensure operator safety and preserve the operating condition of the instrument, you must adhere to these instructions.

CAUTION: Prevent QIF Mechanism Damage

CAUTION

MOVING/LIFTING HP 3235 MAINFRAME OR EXTENDER FRAMES.

See Figure 1. If you have option 590 (Quick Interconnect Mechanism) on your HP 3235 mainframe or extender frames, there are mechanism handles on both sides of the card cage. These handles are used to engage the Quick Interconnect Fixture (HP 34591) to the plug-in modules. **DO NOT** use these handles for moving or lifting the HP 3235. Excessive stress on these handles will damage the mechanism.

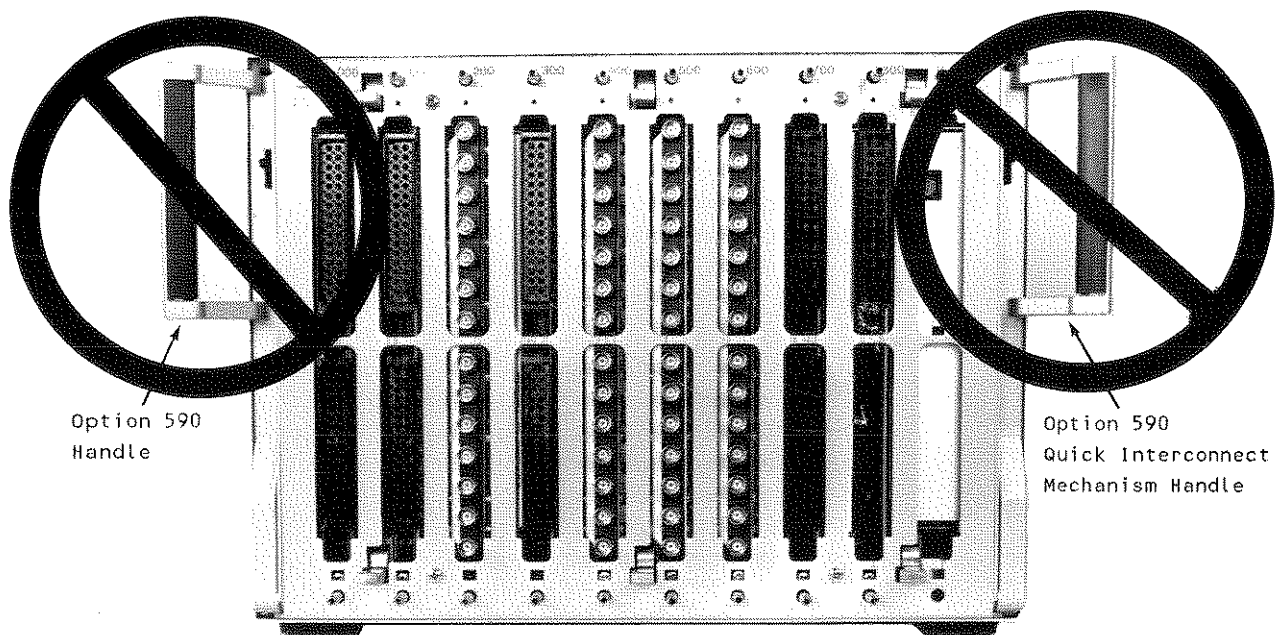

DO NOT lift or move frame with the QIF mechanism handles.

Figure 1. CAUTION: Prevent QIF Mechanism Damage.

**CAUTION:
Prevent
Module
Connector
Breakage**

CAUTION

DISCONNECTING TERMINAL BLOCKS FROM PLUG-IN MODULES.

See Figure 2. Disconnecting a terminal block from an uninstalled plug-in module (one not in a frame card cage) can cause the connector to break if improperly disconnected. For terminal blocks not in a quick interconnect fixture (QIF), the extractors (both top and bottom) must be slowly activated together to disengage the connector. **DO NOT activate one extractor only.** This causes the terminal block to form a lever arm pivoting on the still engaged end. Large stress can be put on the pivoting end causing the connector to break.

Also, when disconnecting a terminal block from an installed plug-in module, use both extractors together to prevent stressing one end of the connector.

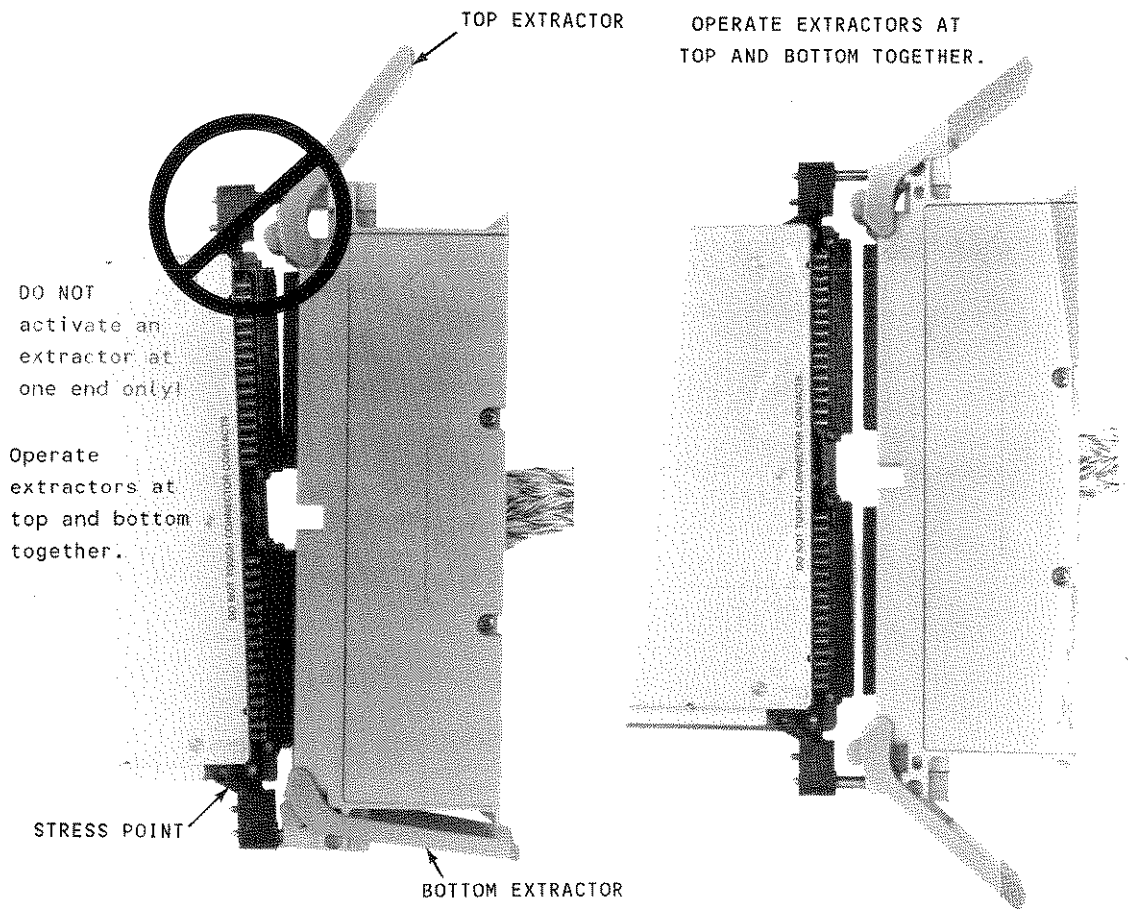

Figure 2. CAUTION: Prevent Module Connector Breakage.

STU Description

The HP 3235 Switch/Test Unit (STU) is a 10-slot programmable mainframe. There are two sideYs to the STU: the system side and the user's side. The system side contains the system modules (crossguard, processor, controller interface, bus access or option 560 extender module, and power supply). Frames are shipped with all system modules installed except the bus access or extender modules. Figure 3 shows the system side with an option 560 Extender module installed (has two digital extender connectors).

Various plug-in modules for the user side can be selected to fit your application. You install these modules into the user side card cage and connect the field wiring to terminal blocks which mate to the modules. Figure 3 shows the user side with the option 590 quick interconnect mechanism handles visible. If more than ten modules are required, an STU Extender can be added to the system providing ten more slots (you can add up to seven extenders to a mainframe). Procedures for connecting extenders in the system are contained in the part 2 installation procedures.

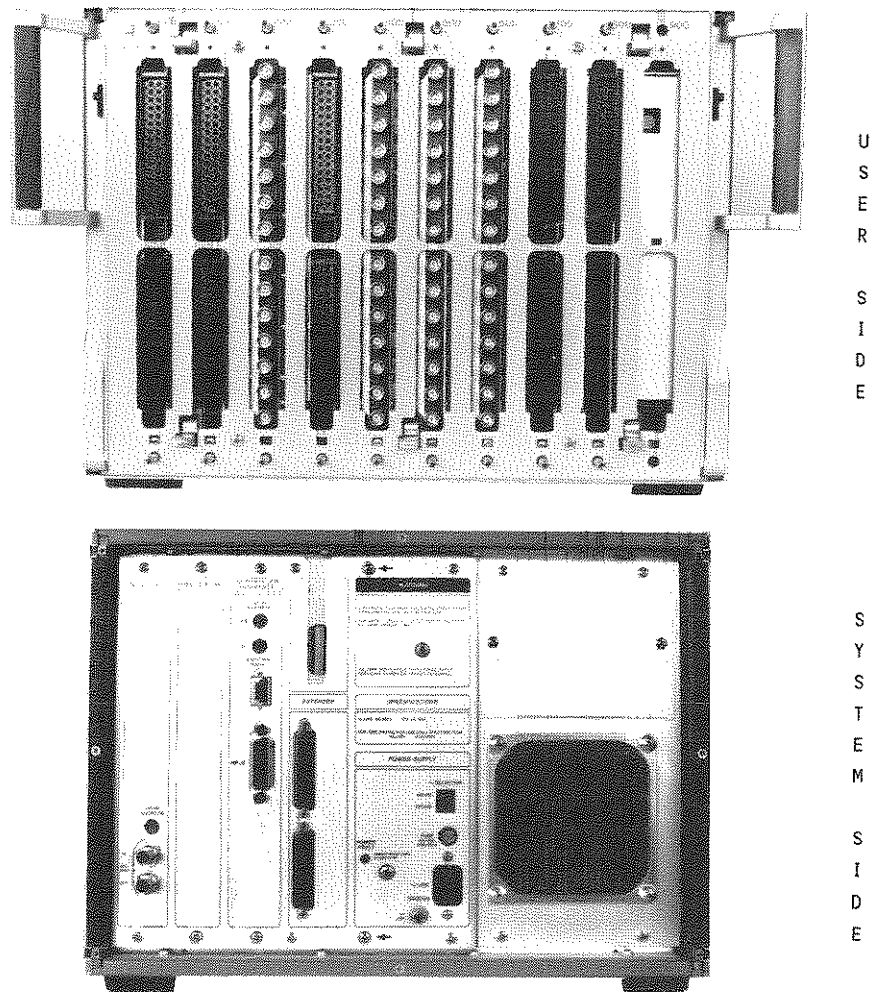

Figure 3. HP 3235 System Side and User Side.

Taking Inventory

When you unpack your HP 3235 STU, verify that all options, plug-in modules, and accessories that you ordered with it have been received. In addition, verify that you have received the documentation, power cord, and line fuses listed in Table 1.

Table 1. Materials Supplied

Qty	HP Part No.	Description
1	03235-90004	HP 3235 Installation Manual
1	03235-90006	HP 3235 User Training Guide
1	03235-10001	HP 3235 User Training Disk
1	03235-90003	HP 3235 Language Reference Manual
1	03235-90005	HP 3235 Quick Reference Guide
1	03235-90001	HP 3235 Programming and Systems Information Manual
1	03235-90002	HP 3235 Plug-in Modules Binder (manuals supplied with each plug-in module)
1	345XX-90001	HP 345XX Programming and Configuration Manual (one with each HP 345XX plug-in module)
1	03235-90010	HP 3235 Service Manual
1	See Fig. 4	Power Cord
1	See Table 3	Line Fuse (5A/120V or 2.5A/250V) and fuse cap
1	0400-0137	Rubber Grommet (approx 60 cm for Feedthrough Panel installation)

If any of these items (or other parts) are missing or were damaged in transit, immediately report the problem to your local HP sales office (see the list in the back of this manual). Additionally, if there was transit damage, file a claim with the carrier. If the shipping container or cushioning material is damaged, it should be kept until the contents of the shipment have been checked for completeness and the instrument(s) have been mechanically and electronically inspected.

Information on the HP 3235 self test is contained in Chapter 13 of the Programming and Systems Information Manual. Procedures for checking the electrical performance of your HP 3235 are given in the HP 3235 Service Manual.

WARNING

If any of the following symptoms exist, or are suspected, do not apply ac line voltage. Do not use the instrument until safe operation can be verified by service trained personnel.

- 1. Visible Damage.*
- 2. Severe Transport Stress.*
- 3. Prolonged storage under adverse conditions.*

If necessary, return the instrument to a Hewlett-Packard service center for service and repair to ensure that safety features are maintained.

Serial Number

Each HP 3235 has a serial number located on a plate beneath the fan grill on the system side. This serial number has the form XXXXAYYYYY where XXXX is the serial number prefix, A is the country of origin (A = USA), and YYYYY is the serial suffix.

Each plug-in module and system module has a serial number located on a label on the module. The serial number has the form XXXXAYYYYY like the HP 3235 frame. An ERC (engineering revision code) label is also on each plug-in module. The ERC number changes with any circuit modification to identify the circuit version present.

We recommend you keep a separate record for these serial numbers. Should your instrument(s) be lost or stolen, the complete serial number is often necessary for tracing, recovery, and insurance claims.

How to Obtain Repair Service

You may have your HP 3235 and plug-in modules repaired at an HP service center at any time, whether under warranty or not. There is a charge for repairs after the warranty period. Contact your local HP Sales and Service Office for instructions prior to shipping the instrument. A list of Sales and Service Offices is located at the back of this manual.

General Shipping Instructions

Should you ever need to ship your HP 3235, remove the plug-in modules from the user side of the frame and package them separately. Use clean handling and antistatic techniques when removing, handling, and packaging the plug-in modules. **WRAP THE MODULES IN ANTISTATIC BAGS.** Be certain that the mainframe and each module is packaged in a protective package (use the original shipping container and cushioning material if possible) to avoid transit damage. Such damage is not covered by warranty.

Attach a tag to the instrument or module identifying the owner and indicating the service or repair needed. Include the model and serial number of the instrument and/or plug-in modules. In any correspondence, identify the instrument by model number and full serial number. We suggest that you always insure shipments.

Environmental Requirements

The environmental information presented in Table 2 lists temperature, humidity, and altitude limits for proper operation and storage of the HP 3235 STU, Extender, plug-in modules, and accessories.

Table 2. Environmental Requirements.

PARAMETER	REQUIREMENT
Temperature (Operating)	0 to 55 C
Temperature (Storage)	-40 to 75 C
Humidity (Operating)	40 C @ 95% RH
Humidity (Storage)	65 C @ 90% RH
Altitude (Operating)	4600m (15000 ft)
Altitude (Storage)	15300m (50000 ft)

PART 1: Installation Required For HP 3235 User Training

The procedures of this section prepare the mainframe for bench operation so you can begin the training lessons in the HP 3235 Training Guide. You do not connect extender frames to the mainframe for the training lessons.

NOTE

When using the HP 3235 on the bench, you must allow for air clearance around the front, back, and sides of the frame. At least two inches (50mm) of clearance must be allowed at the system side of the frame, and one inch (25 mm) of clearance at the user side and frame sides. The fan pressurizes the cavity at the bottom of the frame and forces air through air holes at the bottom of each plug-in module and system side assembly. Air is exhausted through the front, back, and sides. Restricting the air flow by not allowing adequate clearance can cause excessive temperature inside the frame. Excessive temperature reduces reliability of both the system assemblies and plug-in modules.

Your HP 3235 is equipped with feet and tilt stand in place, ready for bench operation.

Power Requirements

This section gives you information on power safety considerations, how to set the line voltage, how to install the line fuse, grounding requirements, and the proper power cord and receptacles.

Your HP 3235 requires an ac power source that is nominally either 100-120 Vac or 200-240 Vac, 48 to 66 Hz, single phase. Maximum power consumption is 550 VA (volt-amps). Before applying power verify that the ac line voltage selection switch (~ SELECTOR) is set to the correct nominal line voltage for your location. A later section titled "Line Voltage Selection" gives the procedure for setting the line voltage.

CAUTION

Before connecting your HP 3235 to an ac power source, verify that the line voltage selection switch on the HP 3235 matches nominal ac line voltage for your location.

Grounding Requirements

Your HP 3235 is equipped with a three-conductor ac power cord. This power cord must either be plugged into an approved three-contact electrical outlet or used with a three-contact to two-contact adapter with the grounding wire (green) firmly connected to an electrical safety (earth) ground. The HP 3235's power receptacle and supplied power cord meet IEC (International Electrotechnical Commission) safety standards.

Power Cords and Receptacles

Figure 4 shows the various power cord configurations that are available to provide power to the HP 3235. A table beneath the individual power plug drawings lists the part number for the power cord with plug. If the appropriate power cord was not included with your instrument, notify your HP sales office for replacement.

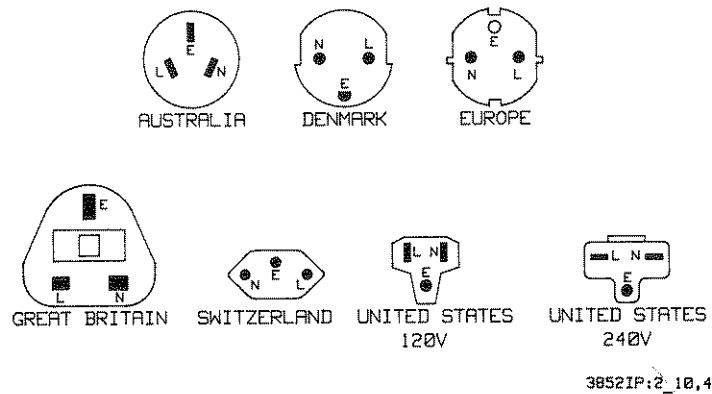

Country	Part Number	Opt.	Voltage
Australia	8120-1369	901	250V 6A
Denmark	8120-2956	912	250V 6A
Europe	8120-1689	902	250V 6A
Great Britain	8120-1351	900	250V 6A
Switzerland	8120-2104	906	250V 6A
United States	8120-1376	903	120V 10A
United States	8120-0698	904	240V 10A

Power cords supplied by HP have polarities matched to the power input socket on the instrument:

- L = Line or Active Conductor (also called "live" or "hot").
- N = Neutral or Identified Conductor
- E = Earth or Safety Ground

NOTE: Plugs are viewed from connector end. Shape of molded plug may vary within country.

Figure 4. Power Cords.

Line Voltage Selection

Refer to Figure 5 when selecting line voltage.

The HP 3235 requires an ac power source that is nominally either 100-120 Vac or 200-240 Vac, 48 to 66 Hz, single-phase.

1. Set the **LINE** switch in the upper left corner of the user side to **STBY** (STBY position is identified under the switch).
2. Remove the power cord from the ~ **LINE** connector if one is installed.
3. Set the ~ **SELECTOR** switch to the desired voltage setting with a flat blade screwdriver.

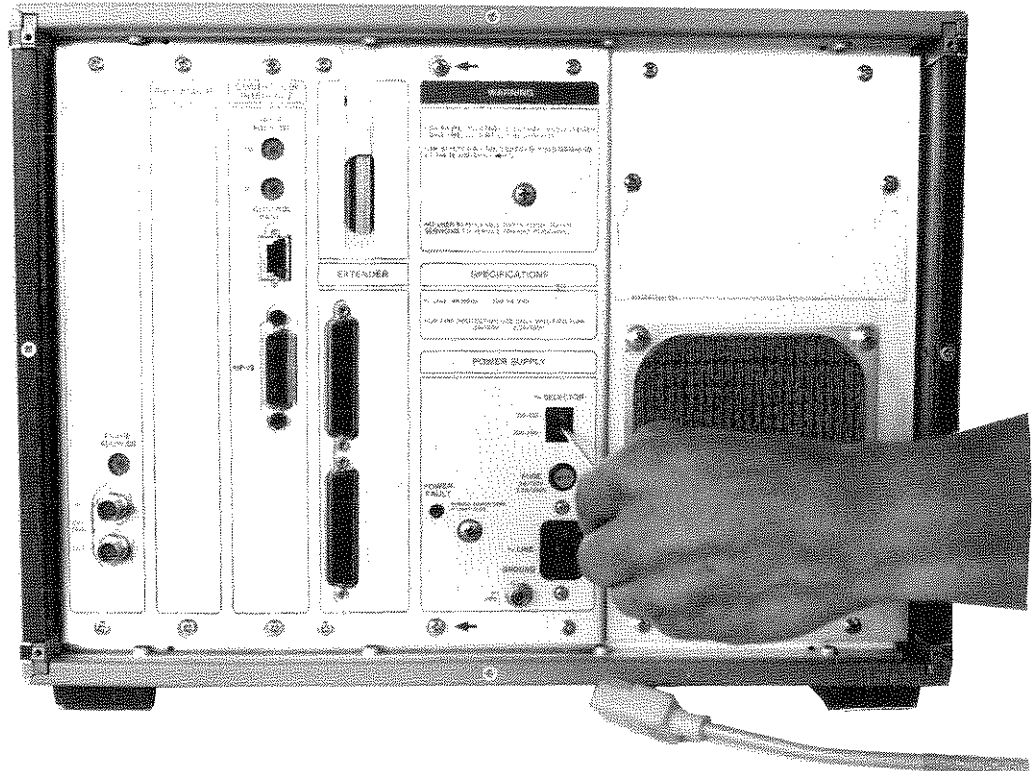

Figure 5. Line Voltage Selection.

Install/ Replace the Power Line Fuse

Refer to Figure 6 to install or replace the power line fuse.

1. Set the **LINE** switch in the upper left corner of the user side to **STBY** (STBY position is identified under switch) and remove the ac power cord from the ~ **LINE** connector if it is installed.
2. Depress and rotate the fuse cap counterclockwise using a small flatblade screwdriver to remove the cap. The fuseholder labeled "**FUSE**" is located on the system side.
3. Install (or replace) the fuse in the cap with the appropriate rated fuse as shown in Table 3.
4. Insert the fuse and fuse cap in the fuse holder, depress and rotate clockwise to reinstall the fuse cap with fuse.

Table 3. Supplied Power Line Fuses and Fuse Caps.

Line Voltage	Power Line Fuse	Fuse Cap
100-120 Vac Nominal (86 to 127 Vac)	5A (English) HP P/N 2110-0010	Gray (for English fuse) HP P/N 2110-0565
200-240 Vac Nominal (195 to 253 Vac)	2.5A (Metric) HP P/N 2110-0681	Black (for Metric fuse) HP P/N 2110-0567

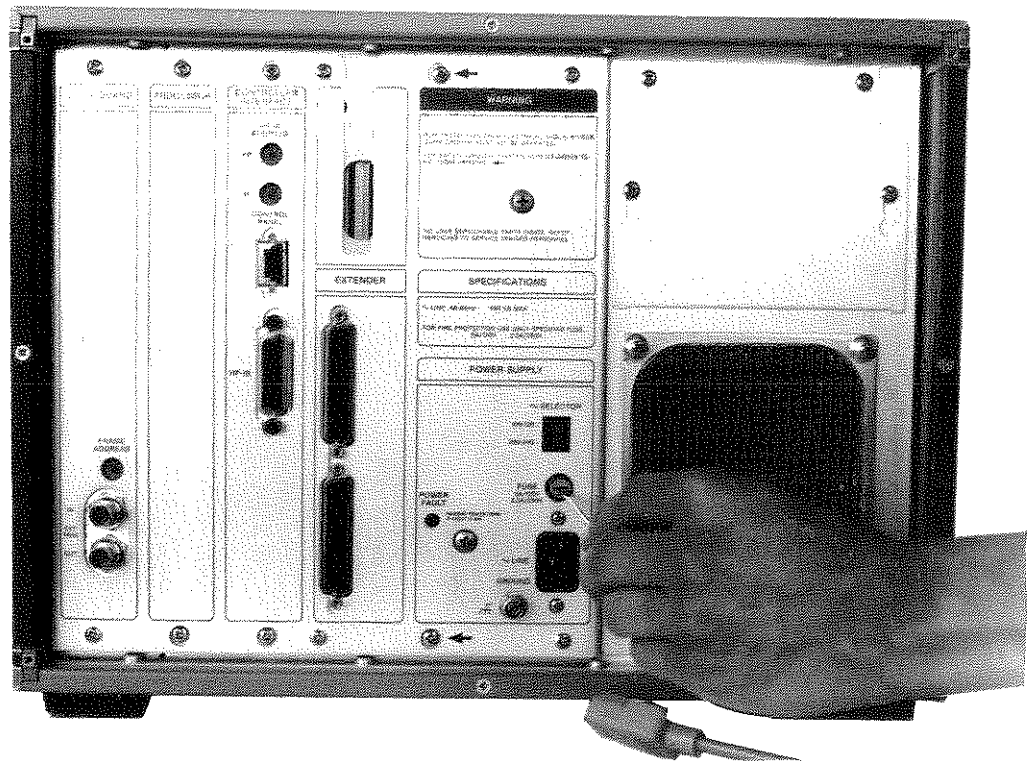

Figure 6. Installing or Replacing the Power Line Fuse.

Setting the Frame Address

The HP 3235 mainframe in the system must have its frame address set to 0. Up to seven extenders can be added to the system and each extender frame must have a unique frame address from 1 through 7. This allows the system controller to selectively address modules in a specific frame.

Refer to Figure 7 for setting the frame address.

1. Use a small flatblade screwdriver to turn the 10-position rotary switch labeled "FRAME ADDRESS" to the address selected.
2. Turn the switch to point the arrow to the number selected for the frame address. (Mainframe must have frame address 0; extenders can have frame address 1 through 7).

NOTE

If the **FRAME ADDRESS** switch is set to 8 or 9, the frame address becomes 0 for a switch setting of 8 (8 MODULO 8). For a switch setting of 9, the frame address becomes 1 (9 MODULO 8). You cannot have two frames in a system with the same frame address even though the frame address switches are set to different numbers i.e. 1 and 9.

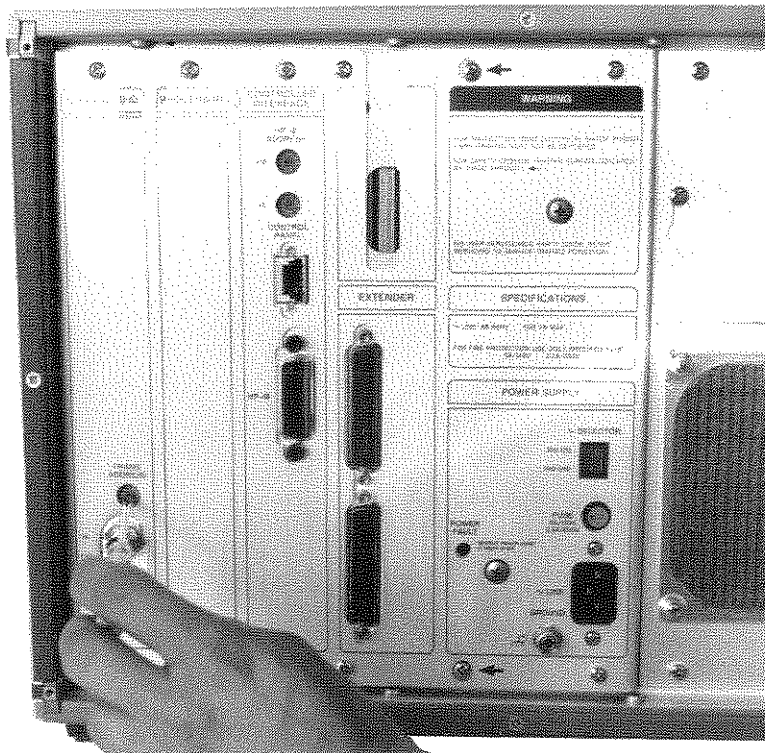

Figure 7. Setting the Frame Address.

HP-IB Interface

HP-IB (Hewlett-Packard Interface Bus) is Hewlett-Packard's implementation of IEEE Standard 488-1978, Standard Digital Interface for Programmable Instrumentation. Technical information about the HP-IB interface is available from your HP sales office.

The HP 3235's HP-IB connector is located on the mainframe system side. Extender frames do not have an HP-IB connection but communicate to the mainframe over the digital bus extender cable. Communication on the HP-IB is handled by the HP 3235 mainframe. A total of 15 HP-IB compatible devices can be connected together on the same interface bus. Cables used with the interface bus have single male/female connectors at each end so that several cables can be stacked, thus allowing more than one cable to be attached to any device. A typical interconnection of HP-IB compatible devices is shown in Figure 8.

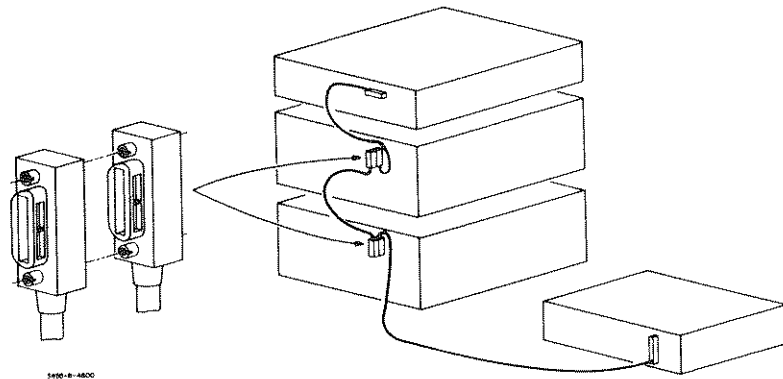

Figure 8. Typical HP-IB System Interconnection.

For best performance, total HP-IB cable length for the system must not exceed 2 metres (6.5 feet) times the total number of devices to be connected or 20 metres (65 feet) total, whichever is less. For example, the maximum cable length would be four metres if only two devices are involved. Do not stack HP-IB connectors more than three deep on any one device.

HP-IB Address Selection

The HP-IB address of your HP 3235 is determined by the setting of two rotary switches on the rear panel. These switches are labeled HP-IB ADDRESS; one switch is the tens digit (X10) and the other is the ones digit (X1). The HP-IB address switches are read when the instrument is turned on or reset. Normally the HP 3235 leaves the factory with the address switches set to decimal 09. The corresponding ASCII code is a listen address of ")" and a talk address of "I". The HP-IB primary address on the HP 3235 must be between 0 and 30 inclusive; secondary addresses are not allowed. No two devices on the interface may share the same primary address. Refer to Table 4 for other HP-IB address codes.

NOTE

The HP-IB ADDRESS (X10 and X1) rotary switches are 10-position switches like the frame address switch of Figure 7. Set the 10's digit and 1's digit by the same procedure shown in Figure 7. If a number (NN) larger than 30 is set, the resulting address will be NN MODULO 30. For example, if 57 is set, the address is 57 MODULO 30 = 27; if 69 is set, the address is 69 MODULO 30 = 09 which is the address the HP 3235 is shipped with.

Table 4. HP 3235 HP-IB Address Codes.

ASCII Code Character		Address Switches		Decimal Code
Listen	Talk	A2	A1	
SP	@	0	0	00
!	A	0	1	01
"	B	0	2	02
#	C	0	3	03
\$	D	0	4	04
%	E	0	5	05
&	F	0	6	06
'	G	0	7	07
(H	0	8	08
)	I	0	9	09 (Shipped from factory with 09)
*	J	1	0	10
+	K	1	1	11
,	L	1	2	12
-	M	1	3	13
.	N	1	4	14
/	O	1	5	15
0	P	1	6	16
1	Q	1	7	17
2	R	1	8	18
3	S	1	9	19
4	T	2	0	20
5	U	2	1	21
6	V	2	2	22
7	W	2	3	23
8	X	2	4	24
9	Y	2	5	25
:	Z	2	6	26
;	[2	7	27
<	^	2	8	28
=]	2	9	29
>	~	3	0	30
		3	1	31 MODULO 30 = 01
		through		
		9	9	99 MODULO 30 = 09

Control Panel Connection

The HP 34550A Control Panel is an accessory of the HP 3235 STU. If you ordered and received a Control Panel, you connect it now for bench operation during the training lessons. The Control Panel cable plugs into the CONTROL PANEL connector in the CONTROLLER INTERFACE section of the system side as shown in Figure 9. At power-on, the Control Panel display indicates the steps in the power-on sequence. The sequence takes about 10 seconds to complete. During the power-on sequence, the display shows "Testing ROM", "Testing RAM", "# Modules Found", and "READY" when the sequence is complete. Apply power by performing the procedure in the next section.

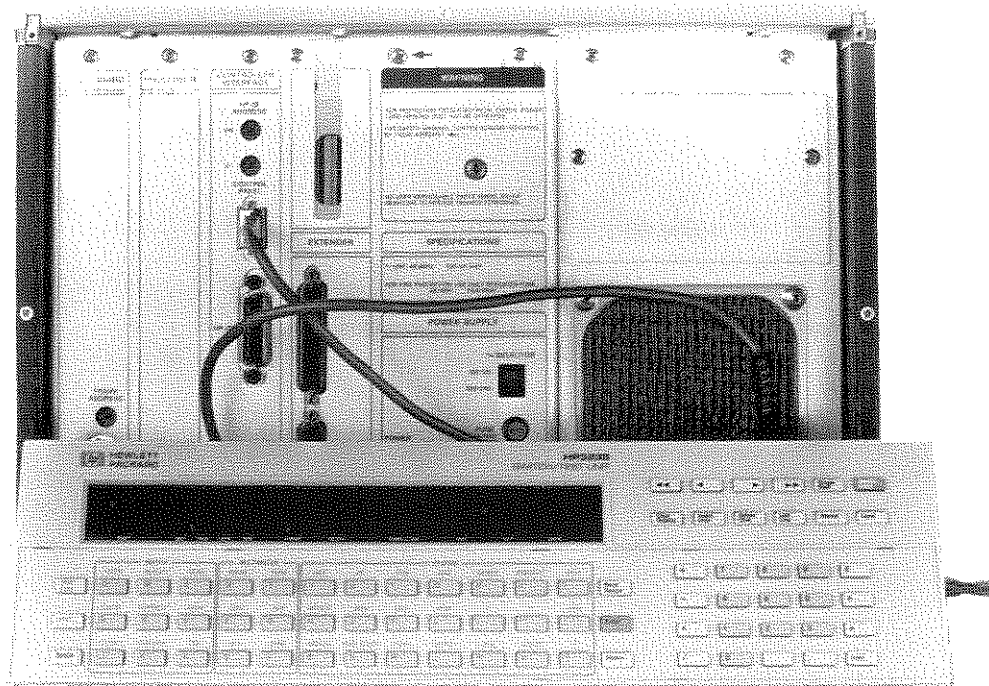

Figure 9. Control Panel Connection.

Applying Power

After the line voltage has been set and the proper fuse installed, you are ready to apply power to the frame. This will ensure the frame is operating properly before plug-in modules are installed and power reapplied.

Verify that the **LINE** switch is in the **STBY** position. Plug the power cord into the electrical outlet then plug the cord into the **LINE** connector in the power supply section of the system side. Depress the **LINE** switch and note that the fan comes on. Refer to the section titled "The Power-on Sequence" in Chapter 2 of the Programming and System Information Manual for more power-on detail.

Power Fault Light

The HP 3235 has a **POWER FAULT** light located in the power supply section of the system side (see Figure 6). If this light is on when power is applied, remove power. The **POWER FAULT** light is on if the HP 3235 overheats due to fan failure or high ambient temperature. It is also on if an over-voltage condition exists on the +15V power supply due to a defect in the power supply or a transient.

Restoring Operation

If a power fault condition occurs, you can restore operation (if it is not due to overheating or a defective power supply) by either cycling the **LINE** switch or by removing the AC power cord and reinstalling it. If you cycle the **LINE** switch to the **STBY** position, the **POWER FAULT** light will remain on (indefinitely) until you cycle the switch to the **ON** position or remove the power cord. When you turn the **LINE** switch on, the power supply resets and turns the **POWER FAULT** light off if the fault has been cleared.

If you remove the AC power cord, you must wait for the **POWER FAULT** light to extinguish before replacing the power cord. The discharge of filter capacitors can keep the light lit for several minutes.

NOTE

If the fault condition is not corrected, the HP 3235 will return to the power fault condition. Check to ensure that the HP 3235's internal cooling fan is working and that the instrument is adequately ventilated. If the power fault condition persists, refer to the HP 3235 Service Manual.

Installing the Plug-In Modules

This section gives you procedures to install plug-in modules into the user side of the HP 3235. You should have successfully powered-up the frame in the previous section "Applying Power". Before installing a plug-in module, put the mainframe on standby power (LINE switch to STBY).

WARNING

Turn off all mainframe, extender, and field wiring power before installing a plug-in module.

CAUTION

STATIC SENSITIVE. *Do not touch connector contacts when handling a plug-in module. Touching contacts can subject components to static charges that can damage them. Always use clean handling techniques when handling plug-in modules.*

CAUTION

TO PREVENT CONNECTOR BREAKAGE, *do not attempt to remove a terminal block from a plug-in module without using the extractors or quick interconnect mechanism (when terminal blocks are installed in a quick interconnect fixture). Install plug-in modules into the card cage before installing terminal blocks. This allows you access to the screws which hold the modules in the card cage. Modules secured in the card cage provide connector support when terminal blocks are installed and removed. When removing a terminal block, always use extractors to partially disengage the terminal block from the module. Failure to do this can excessively stress the connector when one side of the terminal block is disengaged and the other side is still fully engaged.*

NOTE

This section covers installing plug-in modules into a mainframe or extender. Refer to the specific chapter for each plug-in module for any configuration required of a module.

Refer to Figures 10 and 11 to install plug-in modules.

1. Verify the mainframe is in standby power (**LINE** switch to **STBY** and fan is not operating).
2. Remove the user side panel by loosening the upper and lower screws between slots 100 and 200 and slots 700 and 800. See Figure 10.
3. All metal covers must be in place on the modules when installed.
4. Orient the module according to the "THIS EDGE UP" arrow on the cover shown in Figure 11.
5. Insert the module into the cage slot until bracket is flush with the top and bottom sheet metal.
6. Screw the top and bottom screws snug to secure the module. Use a no. 2 pozidriv screwdriver.
7. Remove the slot covers from the panel removed in step 2. Remove only those covers from slots that are occupied by an installed module. Unhook the latch in the middle of the cover and bow the cover to release one end for removal.
8. Reinstall the panel on the user side by securing with the four screws loosened in step 2. The connectors of the installed modules fit through the slot cutouts in the panel.

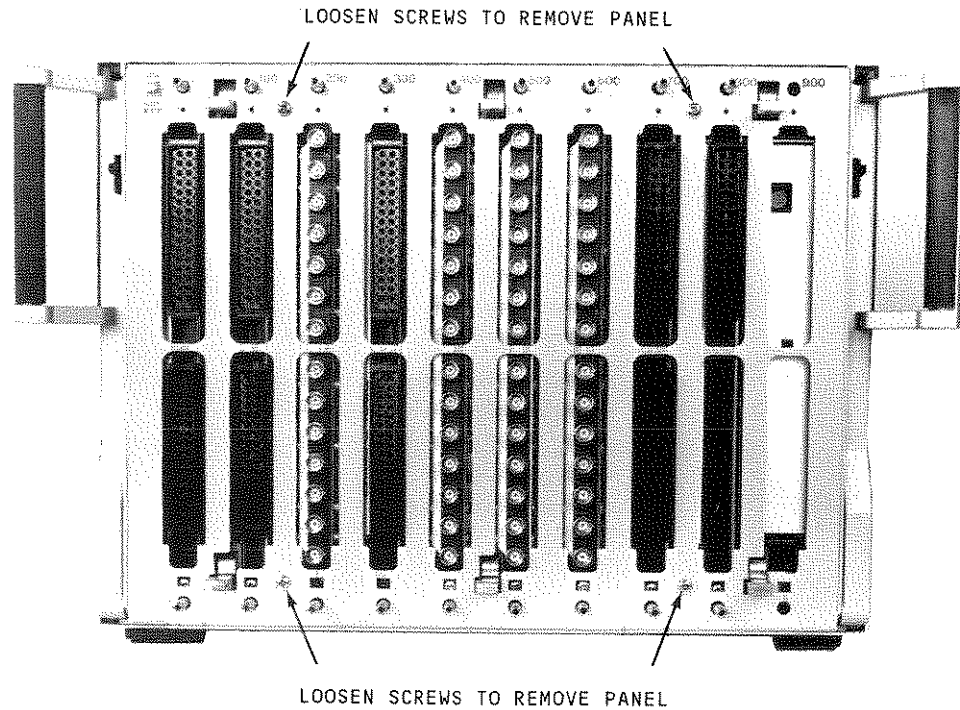

Figure 10. Removing the User Side Panel.

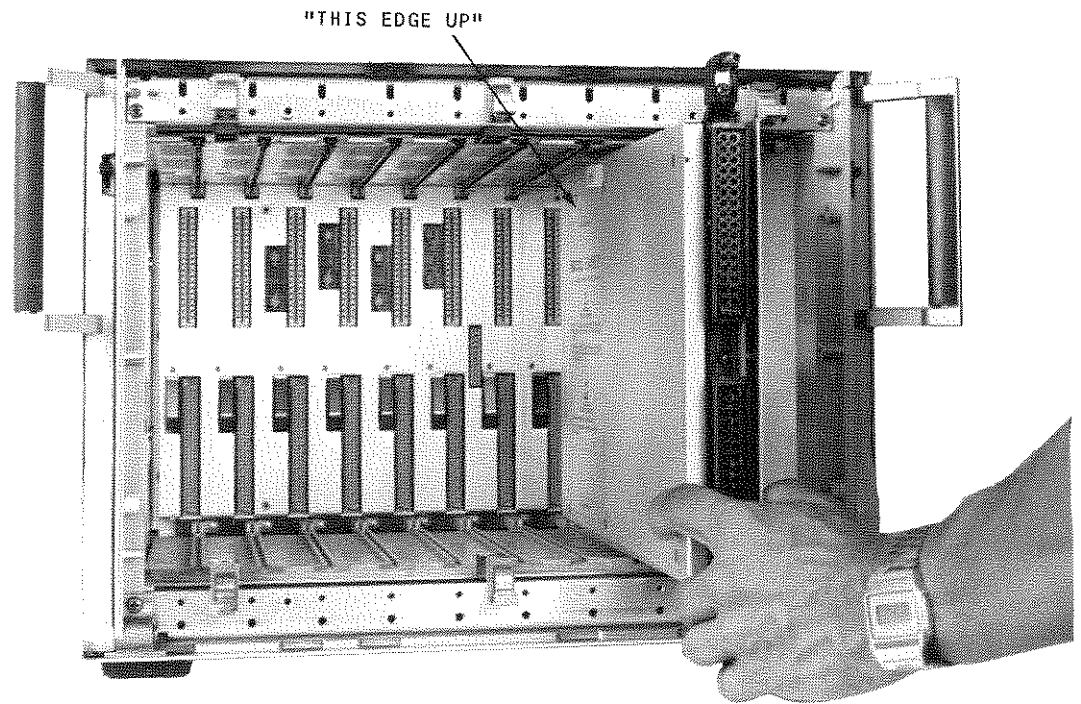

Figure 11. Installing the Plug-In Modules.

NOTE

After the plug-in modules are installed, you are ready for user training lessons contained in the User Training Guide/software disc. The user training is performed without terminal blocks or field wiring installed on the plug-in modules. User training programs are set up to default to slot 200 for the module the lesson is covering. The default for the two-slot Multimeter is slot 800 (occupies slots 800 and 900). The program asks you to identify the slot you have the module installed in. If you install the Multimeter in slots 800 and 900 and the module being covered in the lesson in slot 200, you will not have to enter slot numbers. The lessons default to HP-IB address 09 which is the address the frame is shipped with from the factory.

PART 2: Installation That Is Application Dependent

The installation procedures of Part 2 require that you be familiar with the HP 3235 Switch/Test Unit and the plug-in modules you use. At this point, you should have the HP 3235 STU designed into your test requirement. The wiring and cabling connections should be determined. You should be able to answer the following questions before proceeding with the Part 2 installation.

1. How many HP 3235 Extender frames will you be installing?
-Defines digital bus extender cabling to Extender Modules in each frame.
2. If extender frames are in the system, will the analog bus be extended? If yes, to all frames? To only some of the frames (which ones)?
-Defines analog bus extender cabling to Extender Modules in each frame.
3. If there are no extender frames, will you make connections directly to the mainframe analog bus?
-Defines analog bus extender cabling to the Bus Access Module.
4. Will the user side ground (GUARD) be floating from chassis and earth ground?
-Determines if non-isolating strap is to be removed.
5. Does the system have HP 34593 or HP 34594 feedthrough panels? If yes, is the cabling/wiring defined for these feedthrough panels?
6. Have you determined which slots each feedthrough panel or plug-in module will reside? (Required for installing the slot number on the terminal blocks.)
7. Will terminal blocks be installed in an optional HP 34591 Quick Interconnect Fixture? If yes, you will do this before connecting terminal blocks to the modules.
8. Will the mainframe and extenders, if present, be rack mounted?
-Requires optional rack mount kit.
9. If you have an optional HP 34550 Control Panel, will it be rack mounted using the HP 34551 Control Panel Rack Mount Kit? Mounted slanted or vertical?
-Requires optional Control Panel rack mount kit.

Installing Extenders

This section gives you information for setting up HP 3235 extender frames in your system. If you do not have extenders in your system, go to the section of this manual titled "Installing the Bus Access Module".

To set up an extender frame, you perform the following procedures:

- Set the line voltage and install the proper fuse.
- Set the extender frame address from 1 to 7.
- Connect analog bus extender cables to the HP 34560 Extender Modules (mainframe/extender frames the analog bus is to be connected between).
- Install HP 34560 Extender Modules in the mainframe and extenders (if frames are to be rack mounted, install after frames are in the rack).
- Connect digital bus extender cables (install after rack mounting).

Extender Power Requirements

Power requirements for HP 3235 Extender frames are the same as mainframe requirements. The entire "Power Requirements" section of PART 1 installation applies to extender frames. Establish grounding requirements, set the line voltage, and install the power line fuse as described in PART 1.

Setting Extender Frame Addresses

The frame address for an extender frame must be set from 1 to 7 (you can have a maximum of seven extender frames in one system). This allows the system controller to direct commands specifically to one frame. You set extender frame addresses as shown in "Setting the Frame Address" in the installation procedures of PART 1.

Locating Extenders Near the Mainframe

You are now ready to connect the analog bus extender cables to the extender modules if analog bus extension is needed in your system. This section first gives you information on cable length restrictions which dictates the distance of extender frames from the mainframe.

There are cable length restrictions between the mainframe and all extenders in the system. Analog signals flow through the analog extender cables and digital control signals flow through the digital extender cables. To ensure the integrity of the signals passed between mainframe and extenders, cumulative cable length within a system must not exceed 10 metres for either analog or digital extender cables (i.e. each can have cumulative 10 metres). Therefore, this limits the distance an extender can be placed from the mainframe. Up to seven extenders can be added to a mainframe as long as the cumulative length of digital extender cables does not exceed 10 metres. Also, the cumulative length of analog extender cables must not exceed 10 metres. Figure 12 illustrates the cable length restrictions on a mainframe/extender system.

Your HP 3235 Extender frame comes with standard 1 metre analog and digital bus extender cables. Option 570 supplies 3 metre cables instead of the standard 1 metre cables (3 metre cables are accessory HP 34570A). When deciding where extenders will be located, be aware of whether you have the 1 metre or 3 metre cables.

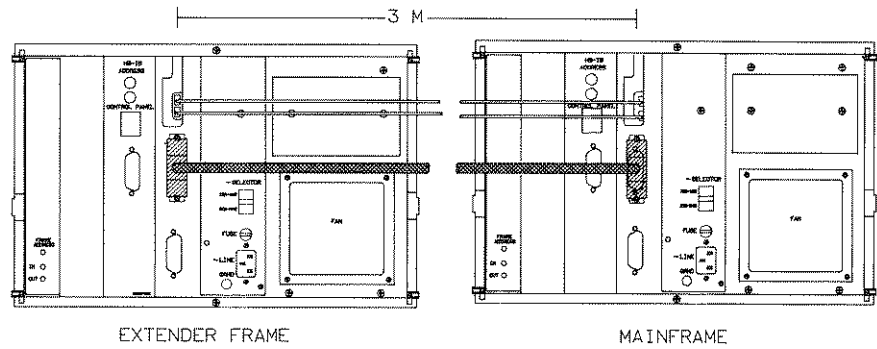

OR

MULTIPLE CABLE SYSTEM

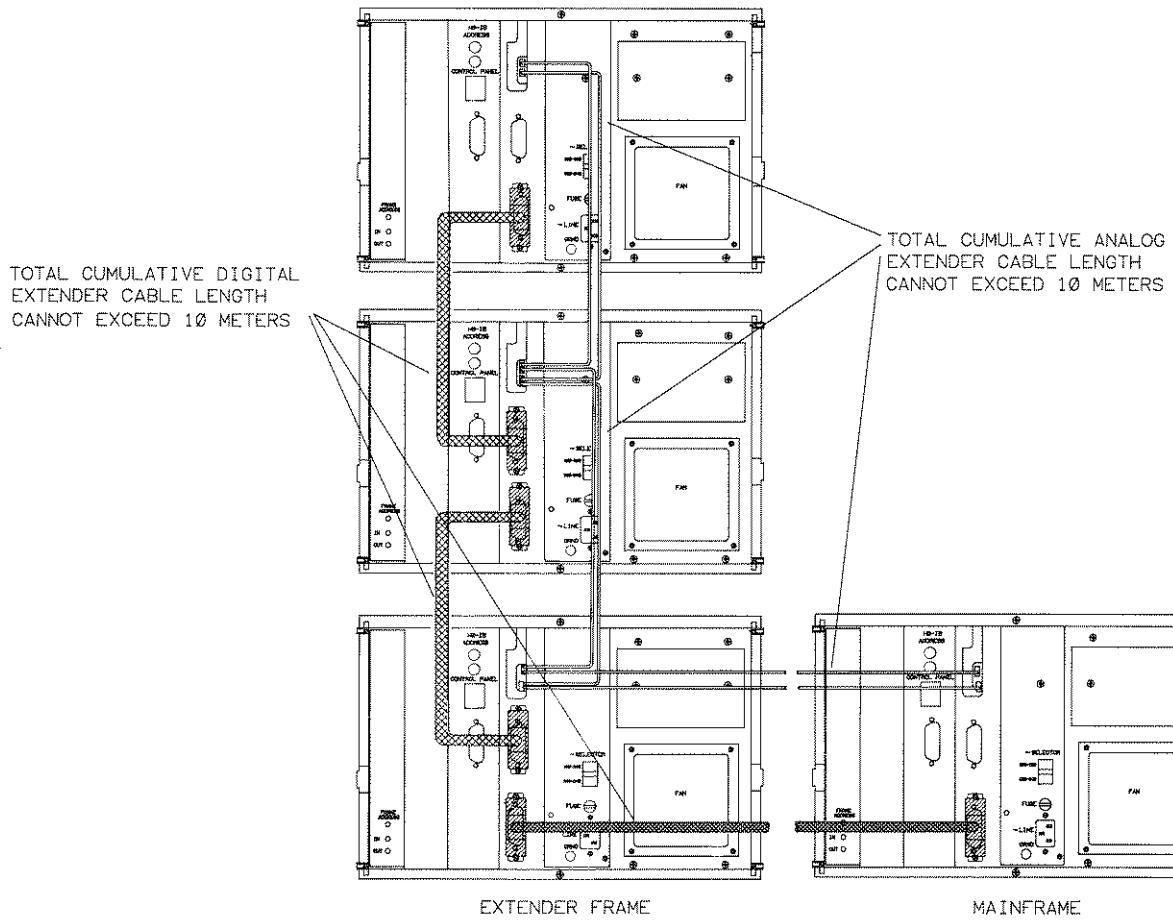

Figure 12. Cable Length Restrictions.

Installing Analog Extender Cables

Analog extender cables connect the analog buses of two HP 3235 frames together via Extender Modules. All frames in a system can have the buses tied together to make one common bus. If no extenders are in the system, external connections to the mainframe analog bus are made through the Bus Access Module. Installing the analog extender cable is optional. The cable needs to be installed only if analog bus connections between two modules in different frames are to be made. The alternative is to not use the analog bus and connect the points through the terminal blocks to a module that has analog bus connections. The maximum cumulative length allowed is 10 metres (see Figure 12).

WARNING

The HP 3235 mainframe and extender frame and certain plug-in modules allow up to 350V peak to be applied to the analog buses. Voltages present on the buses are also present on the terminals and screws of the analog extender connectors. These connectors are located on the HP 34560 Extender Module and must be accessed by qualified, service-trained personnel only.

The following procedure describes the installation of analog extender cables.

- a. Unpack the HP 34560 Extender Modules (one for the mainframe and each extender). An HP 34560 Extender Module is shown in Figure 13.

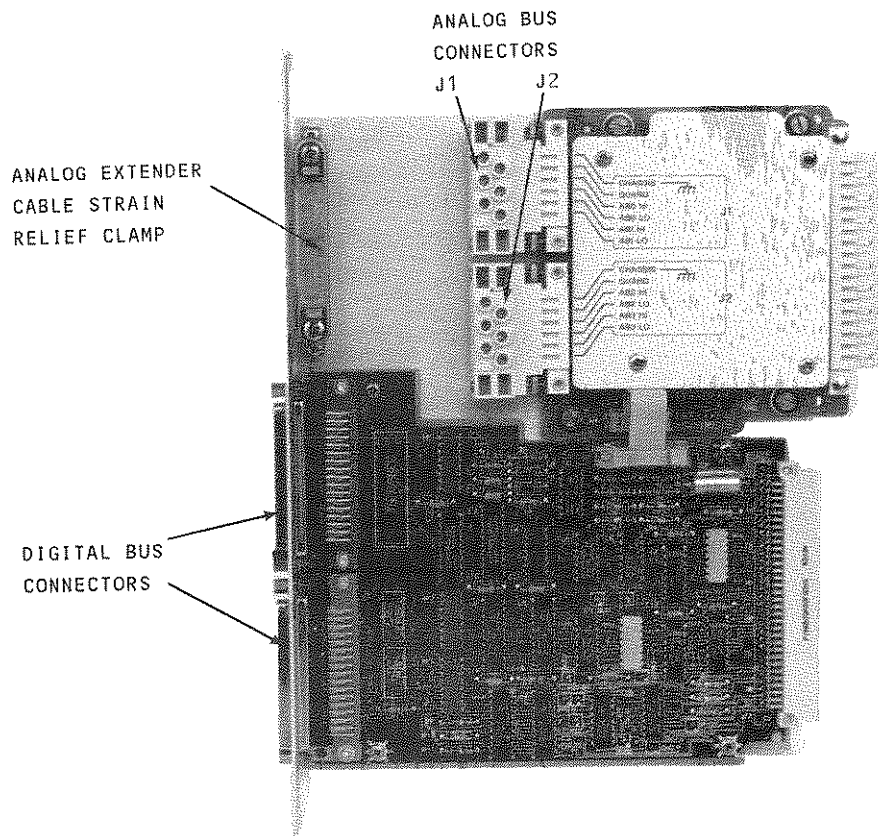

Figure 13. HP 34560 Extender Module.

- b. Remove the strain relief clamp from the module by loosening both captive screws with a no. 2 pozidriv screwdriver. This provides the freedom to loosen the inner screws of connectors J1 and J2 and to align the cables in the clamp base once they are installed on the connectors.
- c. Connectors J1 and J2 can be removed from the module to connect the analog extender cables. Loosen the inside captive screws of J1 and J2 with a no. 1 pozidriv screwdriver by inserting the screwdriver through the strain relief clamp. See Figure 14.
- d. To loosen the outer screws of connectors J1 and J2, the screwdriver must be inserted through the holes on each side of the clamp slot. In each case, the screwdriver will approach the screw head at a slight angle. See Figure 15. Loosen the screws and remove the connectors for cable connection.
- e. Analog bus extender cables are standard 1 metre length. Option 570 replaces the standard 1 metre cables with 3 metre cables. Three metre cables are also available as accessory HP 34570A. Each analog extender cable has six wires which connect into the six screw terminals of connectors J1 and J2. Brown is the chassis, black is guard, orange/white is one HI/LO pair, and blue/yellow is the second HI/LO pair. Each pair extends one bus. Connector J1 extends buses AB0 and AB1; connector J2 extends buses AB2 and AB3. Two cables are required to extend all four buses. Assigning colors to each bus aids in installation (i.e. white = HI0, HI2 and orange = LO0, LO2; blue = HI1, HI3 and yellow = LO1, LO3). **Label each end of all cables "J1" that connect the J1 connectors together. Label those "J2" that connect the J2 connectors together. This decreases the possibility of a wiring error.**
- f. The screws on top of connectors J1 and J2 are shipped in the counter clockwise position so wires can be inserted and clamped by tightening the screws. Verify this with a small, flatbladed screwdriver. Figure 16 shows the screw heads in a top view of connectors J1 and J2. Wires from analog extender cables are shown installed. Install the extender cable wires on connectors J1 and J2 by tightening the screws on the inserted wires: brown to CH, black to GU, orange/white pair to one HI/LO bus, and the blue/yellow pair to the other HI/LO bus.

NOTE

If more than one extender is in the system, each connector has one cable incoming from the previous frame and one cable outgoing to the next frame to daisy chain the analog bus. To daisy chain, you clamp two wires in each connector location (one incoming from one cable and one outgoing from another cable).

- g. Install connectors J1 and J2 back on the assembly. Locations J1 and J2 are silkscreened on the shield directly in back of the connector locations. Each connector is labeled "J1" or "J2".

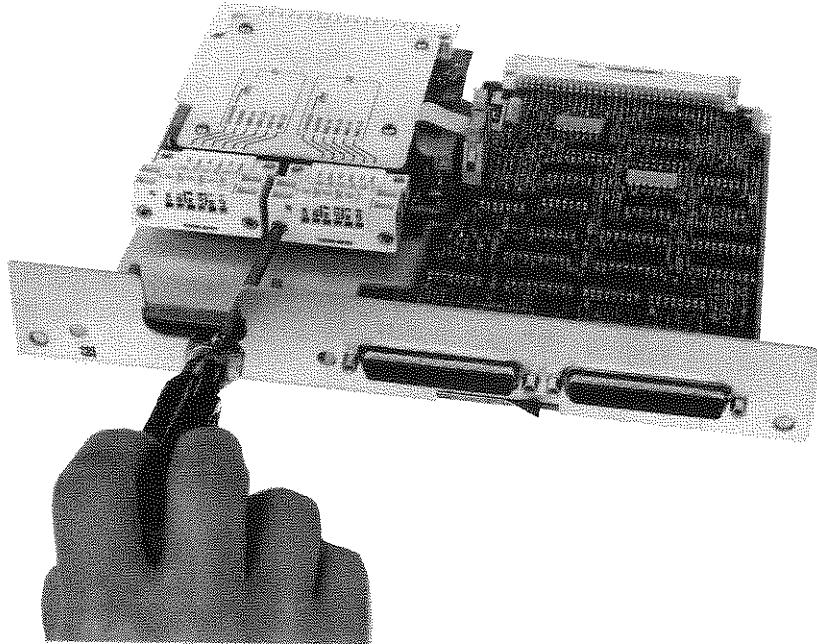

Figure 14. Removing Inner Screws of J1 and J2.

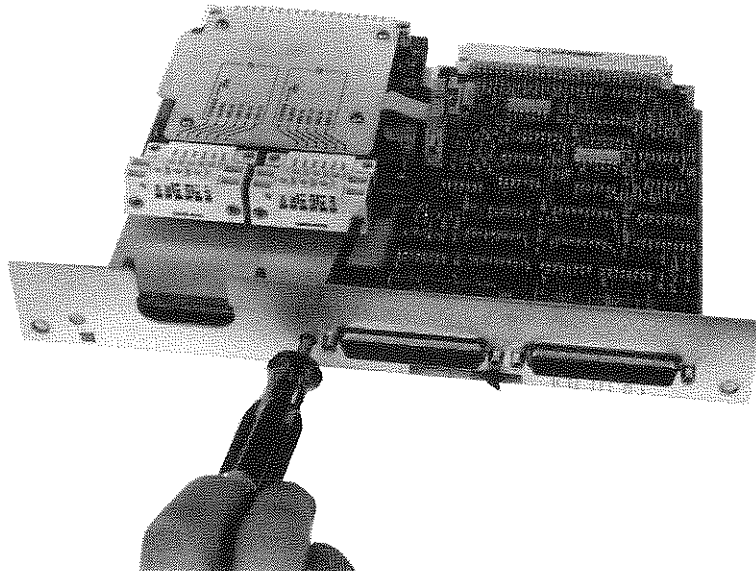

Figure 15. Removing Outer Screws of J1 and J2.

h. Orient the cables in the strain relief as shown in Figure 16 and install the clamp snugly, but not overly tight. Note that the metal ring on the cable assembly is not under the clamp.

i. Make the same connections to J1 and J2 on the other extender modules with the other end of the cables. They should be labeled "J1" or "J2" so all J1 connectors tie together and all J2 connectors tie together.

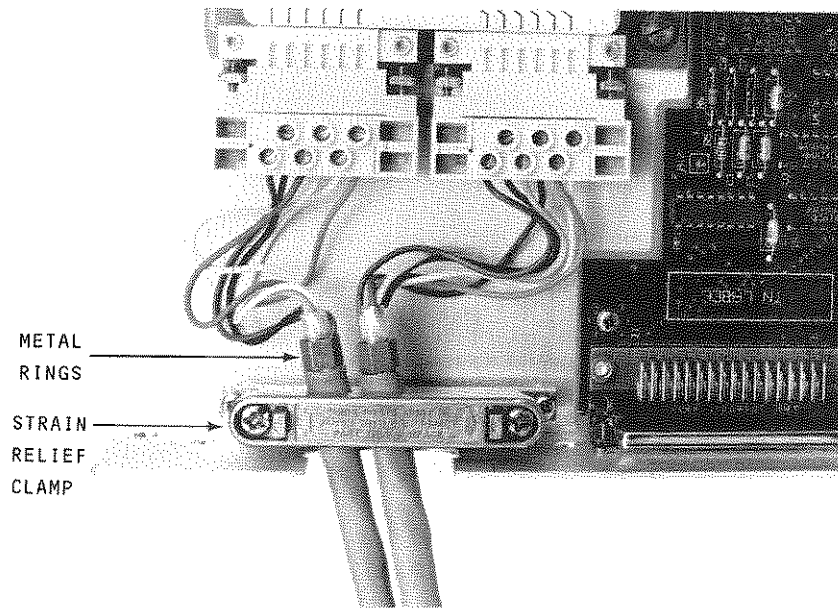

Figure 16. Analog Extender Cable Strain Relief.

- j. If you are rack mounting the frames, install the extender modules after rack mounting. Install the extender modules as described in the section "Installing a Bus Access (or Extender Module)" in this manual.

Installing Digital Extender Cables

The digital extender cable is the communication link between mainframe and extender. Two connectors on the extender module are present for installing the digital extender cable. The connectors are bi-directional and the cable can be attached to either connector. The maximum cumulative length for the digital extender cable is 10 metres (see Figure 12). A digital extender cable is supplied in a standard length of 1 metre. Option 570 replaces the 1 metre cable with a 3 metre cable. The steps required to install a digital extender cable follow.

- a. If rack mounting the frames, install the cable after the frames are mounted. Extender modules, with analog extender cables, should be installed. The system-side panel, containing the silkscreening, should also be in place.
- b. Install the digital extender cable to either connector beneath the **EXTENDER** label. One end to the mainframe and one end to the extender frame. If more than one extender is in the system, connect the second cable from the first extender to the second extender, etc. See Figure 12.
- b. Secure the connectors by tightening the screws on each end of the connector.

Installing a Bus Access (or Extender Module)

This section applies to a mainframe system only (no extenders to install) although the installation procedure for an Extender Module is the same as that for a Bus Access Module. If you have extenders in your system, you begin extender module installation by the procedure given in the previous section titled "Installing Extenders".

Each mainframe comes with a module for extending the analog bus. Shipped individually is either:

1. Bus Access Module (P/N 03235-66204) shipped with a standard mainframe. This module allows "hard-wired" external connections to the analog bus in a mainframe only system.
2. Extender Module (P/N HP 34560A) shipped with an option 560 mainframe and each extender frame. This module extends both the analog and digital buses. The digital bus links the control of the mainframe to each extender. This module has relay contacts that can be programmed to open and close the external connections to the analog buses.

NOTE

The Bus Access Module provides only a "hard-wired" connection to analog buses while the Extender Module provides relay contacts that can be programmed to open or close connections to the analog buses.

WARNING

The HP 3235 mainframe and extender frame and certain plug-in modules allow up to 350V peak to be applied to the analog buses. Voltages present on the buses are also present on the terminals and screws of the analog extender connectors. These connectors are located on the 03235-66204 Bus Access Module and must be accessed by qualified, service-trained personnel only.

Figure 17 shows both of these modules. The modules are shipped uninstalled so that analog bus extender cables can be added prior to module installation in a frame. If no analog bus extending is to be done, simply install the module in the frame for possible future use. After cables are installed, install the modules in the frames as follows.

- a. Remove the metal silkscreened panel which covers the **CROSSGUARD** through **POWER SUPPLY** system modules. Six no. 2 pozidriv screws hold this panel in place and are shown in Figure 18.
- b. If you are making analog bus connections to the Bus Access Module, refer to the section titled "Installing Analog Extender Cables" under Installing Extenders.

c. Insert the Bus Access (or Extender Module) into the empty slot next to the power supply system module (see Figure 18).

d. Reinstall the metal silkscreened panel by sliding the analog extender cables (if installed) into the open slot above the EXTENDER silkscreen. Secure the panel in place with six screws.

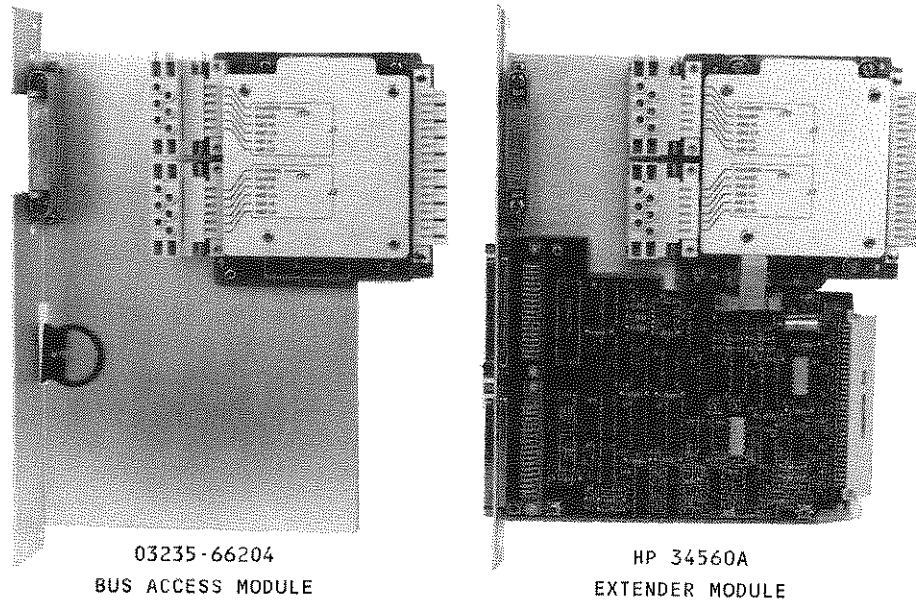

Figure 17. Bus Access and Extender Modules.

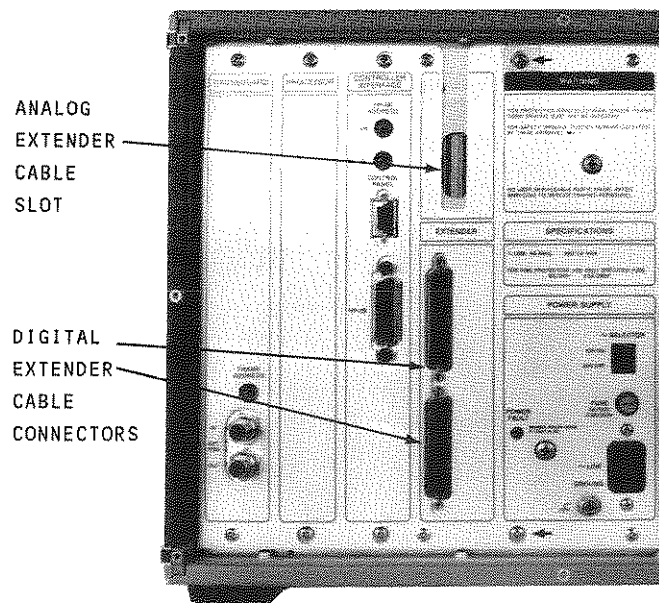

Figure 18. Bus Access or Extender Module Location.

Floating User Side Ground (GUARD)

NOTE

Refer to the section titled "Floating Measurements and Guarding" in the Programming and System Information Manual for information on non-guarded and guarded measurements. The section will also give you information on how to connect and switch the guard when making guarded measurements.

To float the user side ground (GUARD) from chassis ground, do the following:

- a. Set the LINE switch to STBY and disconnect the power cord.
- b. Locate and remove the cover above the fan screen to expose the system side access compartment. See Figure 19. This compartment contains a small PC board and attached strap that isolates GUARD from chassis ground when removed.
- c. Loosen the two screws on the strap.
- d. Insert the blade of a long-shafted, flat blade screwdriver into the rectangular slot on the strap. Swing the strap a) up and b) out to disconnect GUARD from chassis ground. Tighten the two screws. The plug-in module frame is now floating from chassis ground.

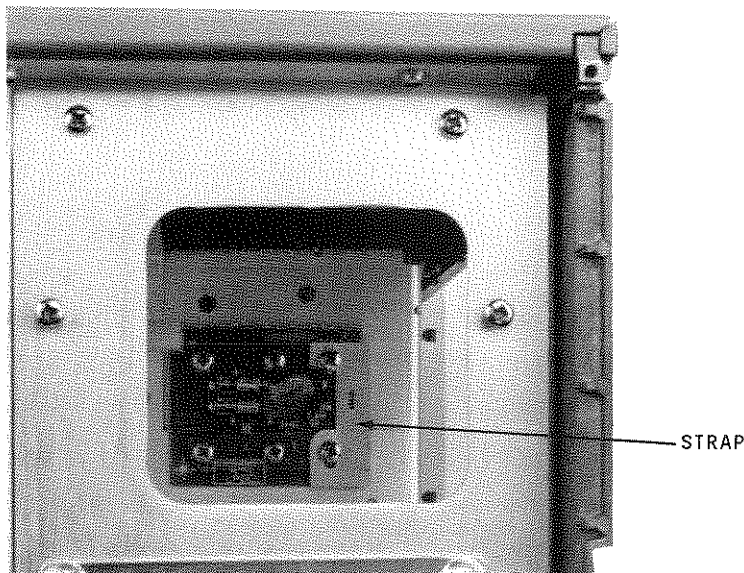

Figure 19. Floating User Side Ground (GUARD).

Feedthrough Panels

Feedthrough panels give you the ability to connect external equipment to connectors that can be mated to terminal blocks. Terminal blocks in a Quick Interconnect Fixture can then be interchanged rapidly without having to disconnect and reconnect the external equipment. Feedthrough panels for high frequency signals (HP 34593) have BNC connectors and the panels for low frequency signals (HP 34594) have DIN connectors. Figure 20 shows a BNC and Low Frequency Feedthrough Panel. This section shows you how to wire and install both low and high frequency panels.

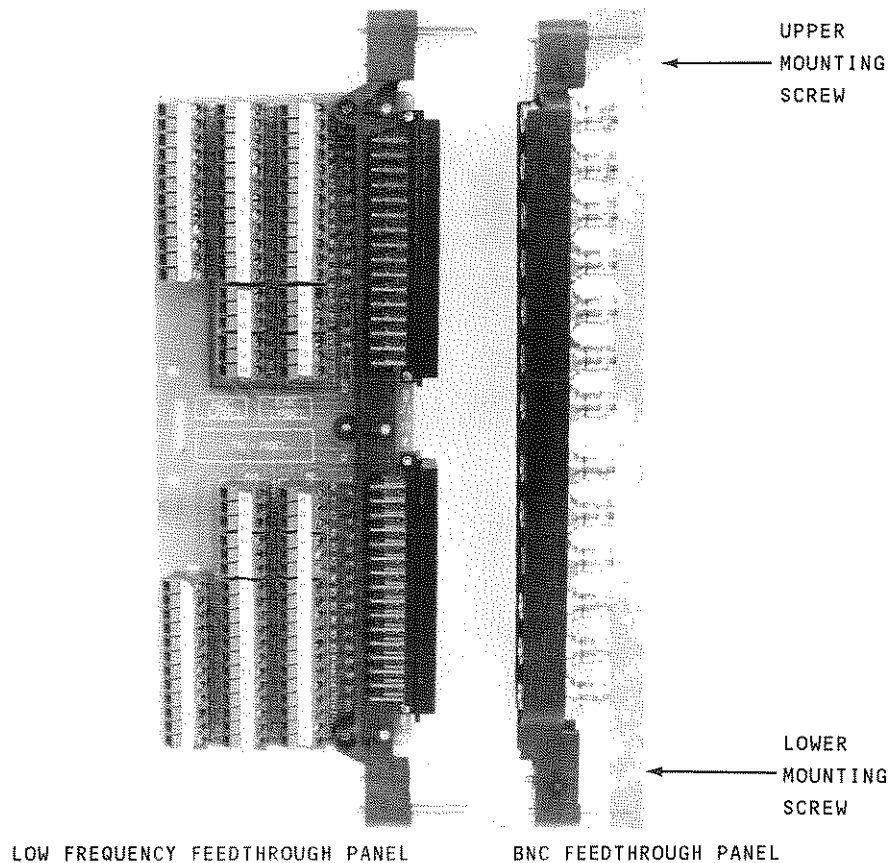

Figure 20. Feedthrough Panels.

The feedthrough panels appear as if they are plug-in modules since they each take the space of one plug-in slot. Cables for BNC connectors or wires for DIN connectors are routed through the back of the HP 3235 (system side) and into the card cage through an access hole next to slot 000. These cables or wires connect to the feedthrough panel from inside the card cage. A terminal block with field wiring is connected to the feedthrough panel from outside the HP 3235 (the terminal block could be installed in a Quick Interconnect Fixture).

NOTE

Feedthrough panels must be installed in the card cage starting with slot 000 and progressing to slot 100, etc. Access for feeding the cables or wires into the card cage is located next to slot 000. A plug-in module in slot 000, that connects to the backplane, blocks the path for feeding cables and wires to all other slots.

BNC Feedthrough Panels

The HP 34593A, B, and C are BNC feedthrough panels. Each panel contains thirteen BNC connectors which are numbered to the right of each connector.

CAUTION

BNC feedthrough panels have numbers to the right of each connector. Seven connectors numbered 1 through 7 are grouped together at the top and six connectors numbered 8 through 13 are grouped together at the bottom. There is more space between connectors 7 and 8 to separate the top and bottom groups. When installing a panel on a card cage, connector number "1" must be at the top for proper mating of terminal blocks.

BNC Terminal Blocks

The HP 34593 BNC feedthrough panels can be supplied with different BNC terminal blocks. The HP 34593A is supplied with a cable terminal block. An HP 34593B is supplied with a bulkhead terminal block and an HP 34593C is not supplied with a terminal block. See the section titled "Terminal Blocks for BNC Plug-In Modules" for complete information on cabling a cable or bulkhead terminal block. The section titled "Connecting Terminal Blocks to Modules" also describes how you connect terminal blocks to feedthrough panels since the panel connectors are the same as module connectors.

Low- Frequency Feedthrough Panels

The HP 34594A and B are low-frequency feedthrough panels. They have DIN connectors which mate to terminal blocks from outside the HP 3235. Internally, low-frequency feedthrough panels have screw-terminal connectors which the feedthrough wiring connects to. For the screw-terminal connectors, you first install connector labels as described in the section titled "Installing Screw-Terminal Connector Labels". The screw-terminal connectors accept a wire size to 18 AWG maximum (1.02 mm diameter, 0.823 mm² cross sectional area).

DIN Terminal Blocks

HP 34594 DIN connector feedthrough panels can be supplied with different terminal blocks. The HP 34594A is supplied with a terminal block having solder-eye/slide-on connectors and the HP 34594B is supplied with terminal blocks having screw terminal connectors. See the section titled "Terminal Blocks for DIN Plug-In Modules" for information on wiring a solder-eye/slide-on connector or a screw terminal connector. The section titled "Connecting Terminal Blocks to Modules" also describes how to connect terminal blocks to feedthrough panels since the panel connectors are the same as module connectors.

Routing Feedthrough Panel Cables or Wires

This section describes the procedure for routing cables or wires into the card cage for connection to feedthrough panels. The procedure steps are listed here and depicted in Figures 21 through 25.

1. Remove the system-side access compartment cover (Figure 21).
2. Remove the frame's left side panel (Figure 22).
3. Remove the panel in front of the card cage (Figure 23).
4. Remove the card cage access cover (Figure 24).
5. Install PN 0400-0137 rubber grommet around two openings (Figure 25).
6. Route the feedthrough cables or wires into the card cage (Figure 25).

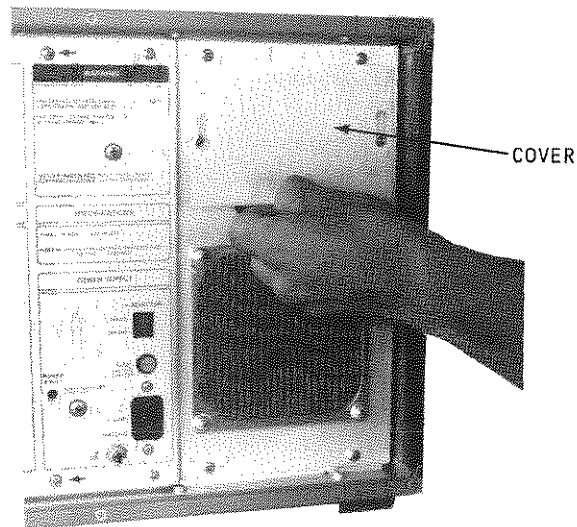

Figure 21. Removing System-Side Access Cover.

LOOSEN ONE SCREW AT SYSTEM SIDE OF PANEL AND SLIDE OUT

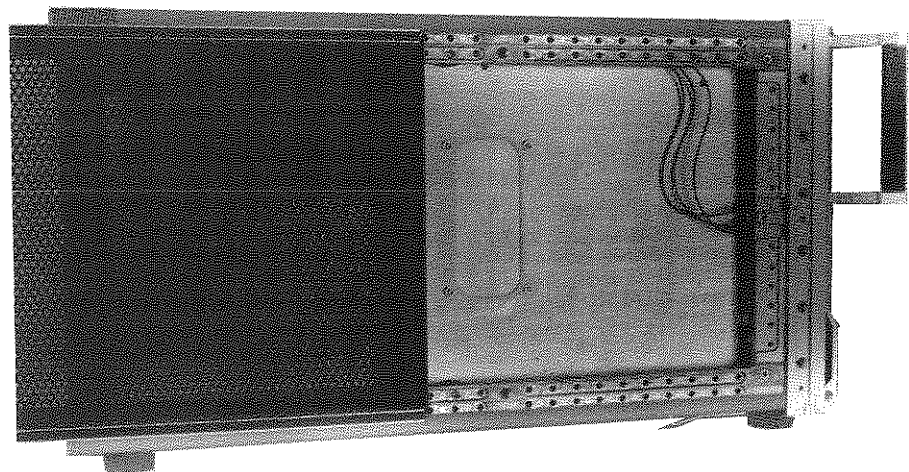

Figure 22. Removing Frame Left Side Panel.

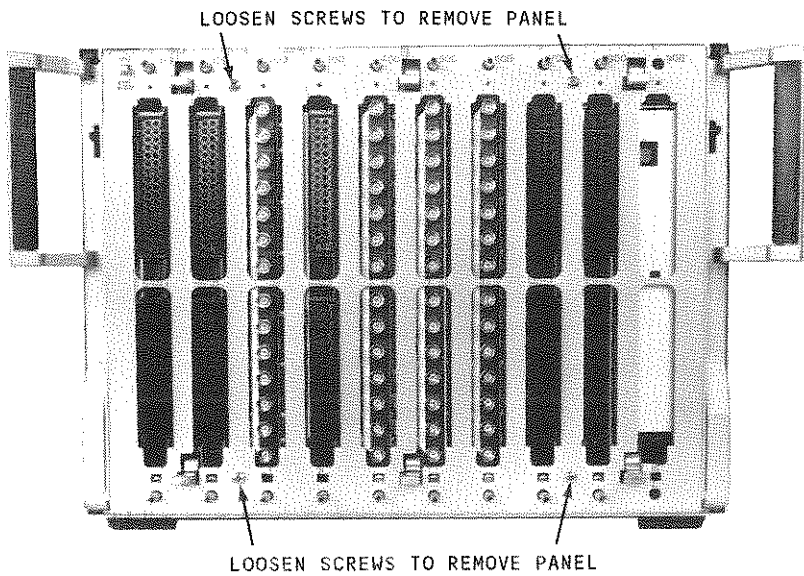

Figure 23. Removing Card Cage Front Panel.

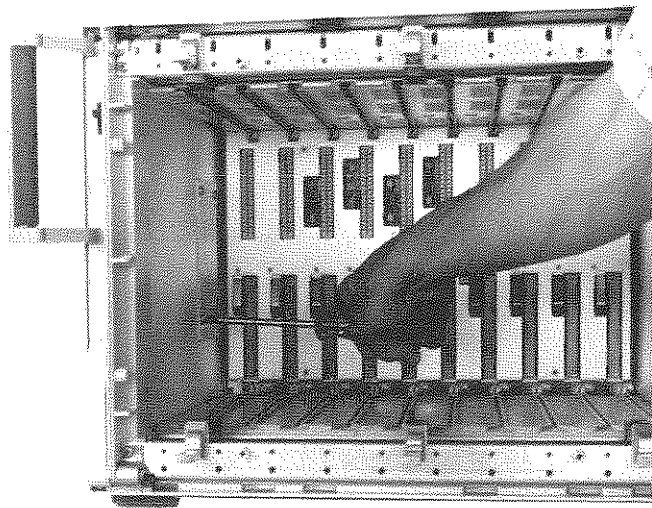

Figure 24. Removing Card Cage Side Access Cover.

Connecting Cables or Wires to Feedthrough Panels

Cables connect to the BNC Feedthrough Panels and wires connect to the Low-Frequency (DIN connector) Feedthrough Panels. The BNC connectors are locking type for connecting feedthrough cabling. The Low-Frequency Feedthrough Panels have screw-terminal connectors for connecting feedthrough wiring. Figure 26 shows connections being made to a BNC panel and Figure 27 shows connections being made to a screw-terminal panel. The screw-terminal connectors accept wire size up to 18 AWG (diameter = 1.02 mm, cross sectional area = 0.823 mm²).

INSTALL RUBBER GROMMET
(0400-0137) AROUND METAL EDGE

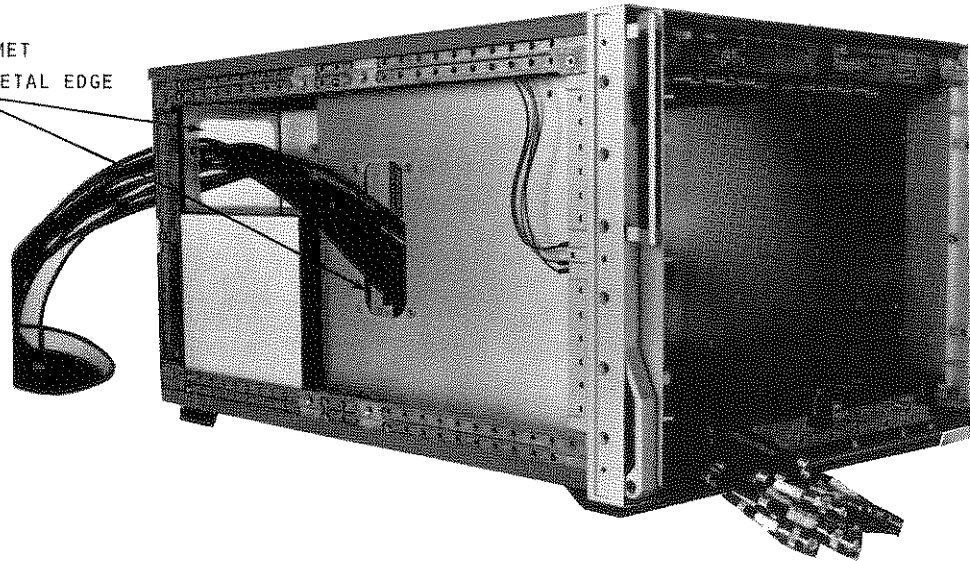

Figure 25. Routing Cables or Wires to the Cage.

INSTALL RUBBER GROMMET
(0400-0137) AROUND METAL EDGE

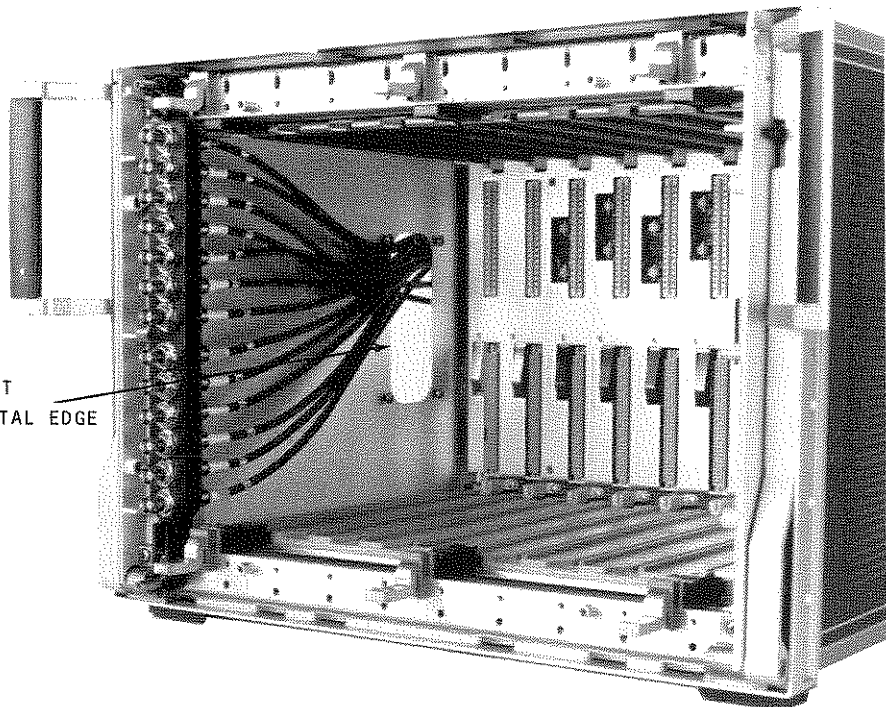

Figure 26. Connecting Cables to BNC Feedthrough Panel.

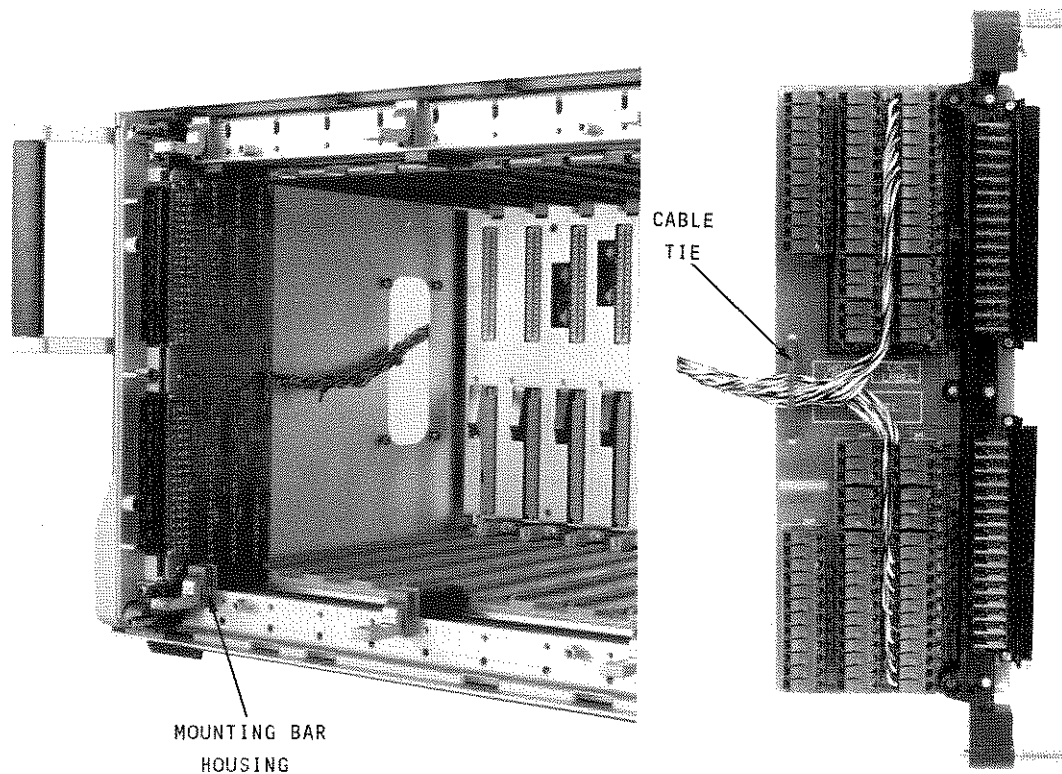

Figure 27. Connecting Wires to DIN Feedthrough Panel.

Installing Feedthrough Panels

The feedthrough panels are secured on the card cage by an upper and lower mounting screw (see Figure 20). The panels must be installed starting with slot 000 (left-most slot) to allow feedthrough cables or wires access to the panels. A full module in slot 000 blocks the feedthrough wiring path. Figures 26 and 27 show feedthrough panels installed after cables or wires have been connected.

NOTE

A Low-Frequency Feedthrough Panel installed in a slot immediately to the right of a quick interconnect fixture mounting bar (see Figure 27), will touch the mounting bar housing. When the panel is installed in the card cage, the top of the screw-terminal connectors sit against the housing. This is normal and does not interfere with operation of the system.

Terminal Block Preparation

There are terminal blocks for BNC and for DIN connector modules. Before installing field cabling or connecting a terminal block to a module, you prepare the terminal block for installation by installing labels to it for later identification and to note cabling assignments. You will also remove terminal block extractors if and only if, the terminal blocks are to be installed in the HP 34591 Quick Interconnect Fixture.

Installing ID Labels

Each terminal block is supplied with module ID, slot number, and terminal assignment labels. Module ID and slot number labels are attached to the outside of the terminal block housing to indicate which module is installed in the slot. The terminal assignment label identifies the module's terminals and is installed inside the terminal block cover. This label is necessary when making field wiring connections. Figure 28 shows where these labels can be installed.

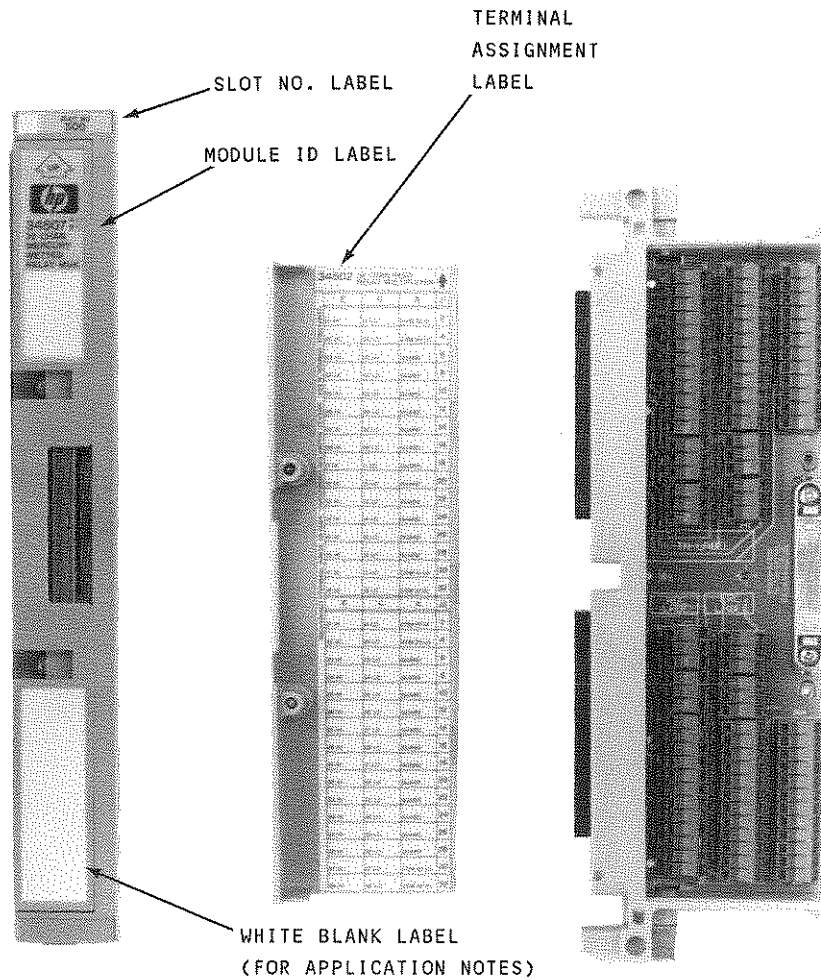

Figure 28. Labels Installed on Terminal Blocks.

Terminal Assignment Label

The terminal assignment label indicates what each module assigns to the terminals of module connectors J1 and J2. The top half of the label represents J1 while the bottom half represents J2. The narrow, right-hand column lists the connector row numbers 2 through 32 (even numbers only). The connectors have three columns of terminals labeled E, C, and A. This forms a row and column matrix for locating a particular terminal. For example, Figure 29 shows the HP 34522 Digital I/O terminal assignment label. To find the terminal that the bi-directional data line "13" is assigned to, look at the column-row matrix to see its assignment is terminal E24 (column E, row 24) of connector J2.

THREE COLUMNS OF CONNECTOR PINS E, C, AND A

ROW NOS. 2 TO 32 (EVEN ONLY)

34522 DIGITAL I/O

	E	C	A	J1
H00	GUARD	INT 0		2
H01	GUARD	INT 1		4
H02	GUARD	INT 2		6
H03	GUARD	INT 3		8
H04	GUARD	INT 4		10
H05	GUARD	INT 5		12
H06	GUARD	INT 6		14
H07	GUARD	INT 7		16
H10	GUARD	TRIG BUS 0 (OUT)		18
H11	GUARD	TRIG BUS 1 (OUT)		20
H12	GUARD	INT STATUS (OUT)		22
H13	GUARD	SYNC (IN/OUT)		24
H14	GUARD	ERROR (OUT)		26
H15	GUARD	ERROR (OUT)		28
H16	GUARD	EXT TRIG (IN)		30
H17	GUARD	EXT TRIG (OUT)		32
	E	C	A	J2
00		00	CTL 00	2
01		01	I/O 00	4
02		02	FLG 00	6
03		03	GUARD	8
04		04	CTL 10	10
05		05	I/O 10	12
06		06	FLG 10	14
07		07	GUARD	16
10		00	CTL 20	18
11		01	I/O 20	20
12		02	FLG 20	22
13		03	GUARD	24
14		04	CTL 30	26
15		05	I/O 30	28
16		06	FLG 30	30
17		07	GUARD	32

COMPATIBLE TERMINAL BLOCK - 34522 AT SOLID STATE I/O CONNECTORS - 34522 AT SOLID STATE I/O CONNECTORS

MODULE CONNECTOR J1

MODULE CONNECTOR J2

COLUMN E
ROW 24
"BI-DIRECTIONAL DATA LINE 13"

Figure 29. Terminal Assignment Label.

Installing Screw- Terminal Connector Labels

Terminal blocks that have DIN connectors are supplied with screw-terminal connectors for modules having a "B" suffix. When you connect wires to these connectors, the PC board silk-screened identifiers are covered by the wires. You can attach labels supplied with the terminal block, to the top of each screw-terminal connector for identification after wires are attached. Figure 30 shows the installation of screw-terminal connector labels. The "A" suffix solder-eye/slide-on connectors do not need labels like these.

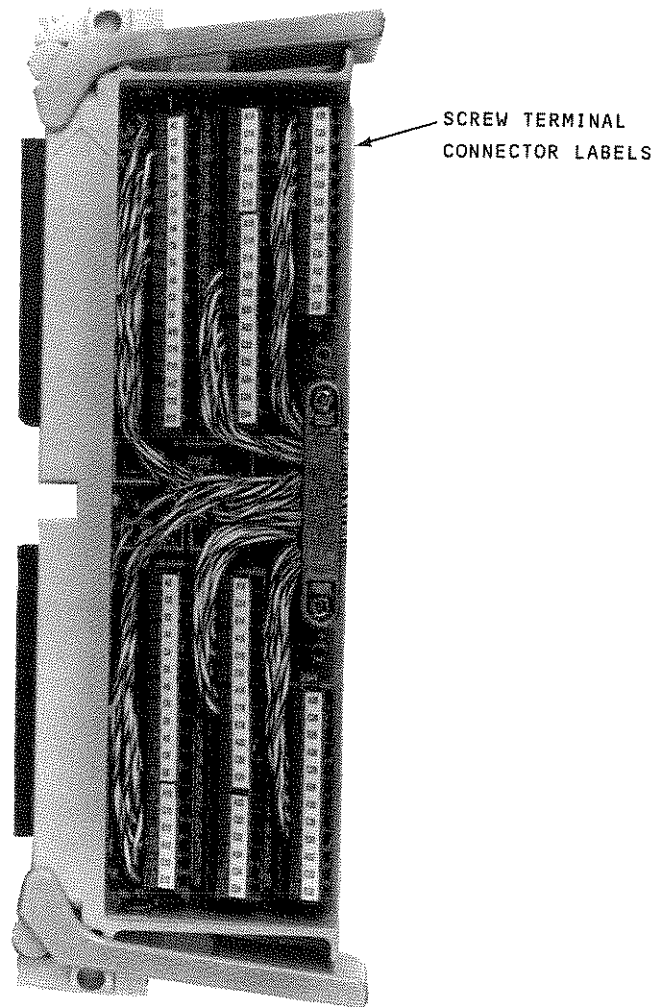

Figure 30. Installing Screw-Terminal Connector Labels.

Removing Terminal Block Extractors

Terminal blocks are supplied with extractors installed. These extractors are required to disengage the terminal block from the module connectors when you want to remove the terminal block. Rotating the extractors away from the terminal block partially disengages the connectors. If you are using an HP 34591 Quick Interconnect Fixture, you must remove both upper and lower extractors so the terminal block can be installed in the fixture. Figure 31 shows an extractor on a terminal block and the procedure for removing the extractor.

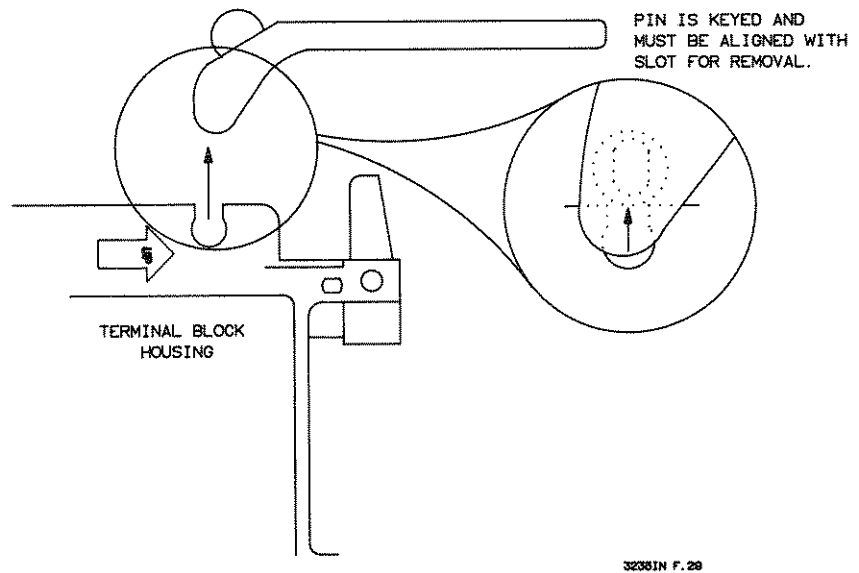

Figure 31. Terminal Block Extractor Removal.

Terminal Block Styles

This section shows you the different styles of terminal blocks available for both BNC and DIN connector plug-in modules. Figure 32 is a collage of the four terminal block styles for easy comparison. The two BNC terminal blocks are the cable terminal block and the bulkhead terminal block. The two DIN terminal blocks are the solder-eye/slide-on terminal block and the screw terminal block. Each style is identified in Figure 32.

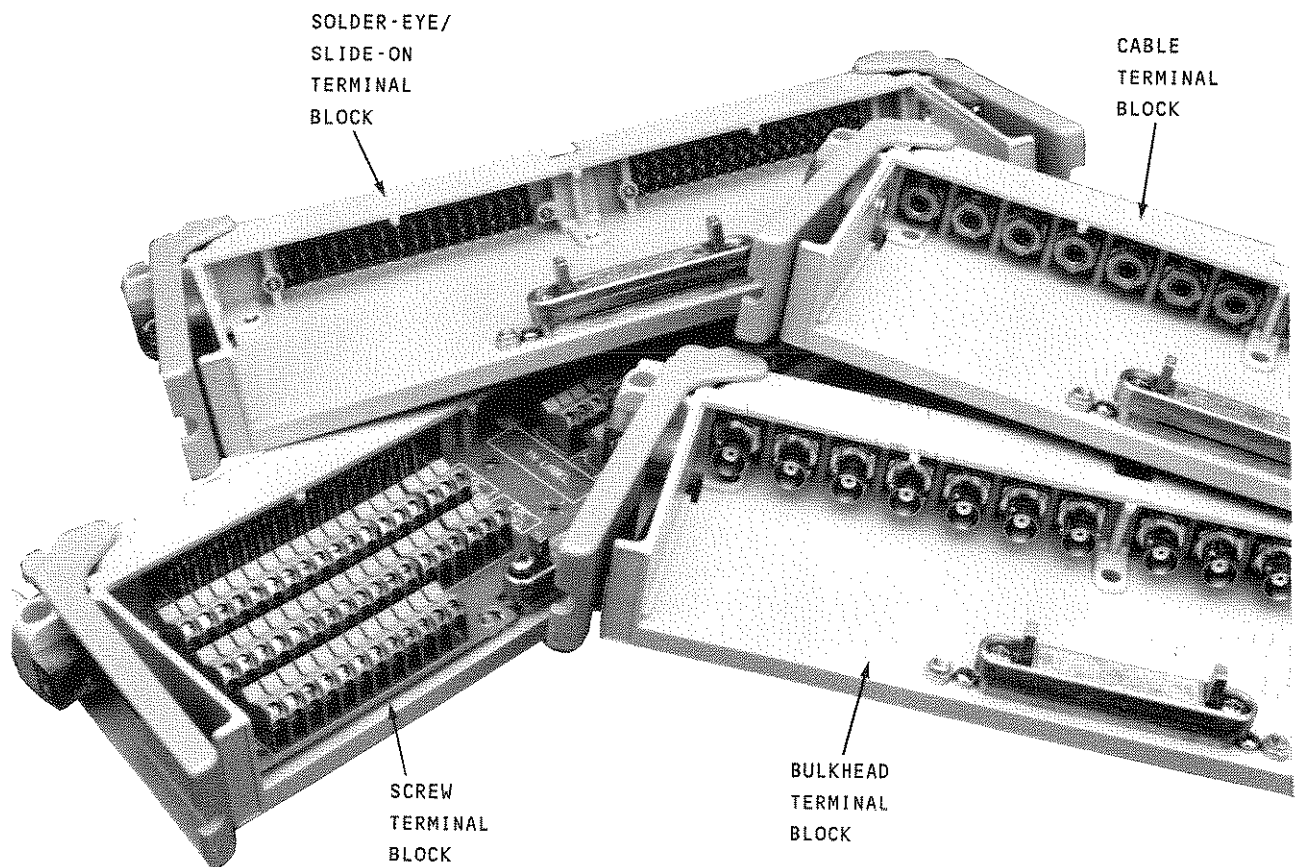

Figure 32. Terminal Block Styles.

Terminal Blocks for BNC Plug-In Modules

The HP 34504, 34505, and 34506 plug-in modules have lockable female BNC connectors for user connections. These female BNC connectors accept user-supplied locking male BNC connectors or the non-locking BNC connectors supplied with the cable or bulkhead terminal blocks. The cable terminal block is supplied with BNC modules having an "A" suffix in its model number (e.g. HP 34506A). The bulkhead terminal block is supplied with modules having a "B" suffix (e.g. HP 34506B). No terminal block is supplied with modules having a "C" suffix (e.g. HP 34506C).

Cable Terminal Block

Figure 33 shows an assembled cable terminal block supplied with the HP 34504, 34505, or 34506 modules with an "A" suffix. This terminal block is used when the wiring configuration is not likely to change often. It contains non-locking BNC male connectors which mate to the module. Field cabling is soldered directly to these connectors opposite the module. The non-locking connectors allow the entire cable terminal block to be removed from the module and reconfigured. However, since the cables are permanently attached to the cable terminal, it is not as easy to reconfigure as the bulkhead terminal block. For rapid system reconfiguration, the cable terminal block can be removed and replaced by another pre-wired terminal block (extra cable terminal blocks are available as accessories). The cable terminal block also makes the plug-in module compatible with the optional Quick Interconnect Fixture. Refer to the section titled "Installing the Quick Interconnect Fixture" for more information.

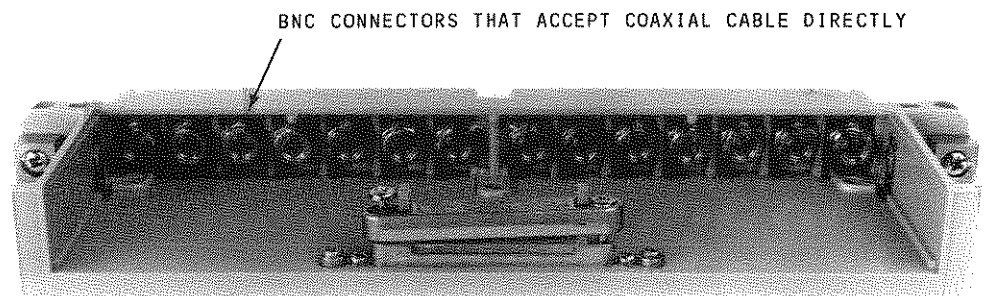

Figure 33. Cable Terminal Block.

Cabling the Cable Terminal Block

The cable terminal block is supplied with non-locking male BNC-to-cable connectors. The cable connecting to these connectors is the user supplied field cabling. RG-223/U coaxial cable is recommended. Figure 34 shows how to connect a coaxial cable to a BNC connector.

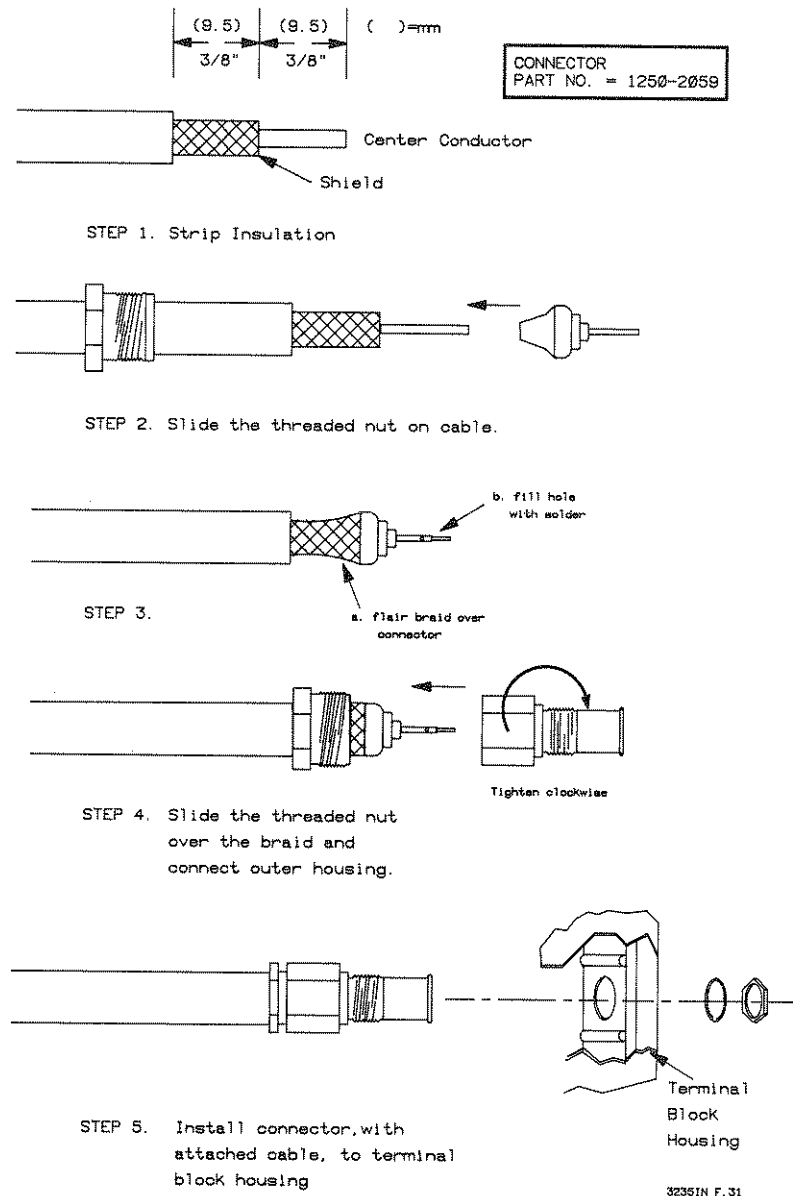

Figure 34. Assembling Cable to BNC Connector.

Bulkhead Terminal Block

Figure 35 shows the bulkhead terminal block supplied with the HP 34504, 34505, or 34506 modules with a "B" suffix. This terminal block contains non-locking male BNC connectors on the module side, and lockable female BNC connectors for your field cable connections. These female BNC connectors accept user-supplied standard male BNC connectors. The non-locking BNC connectors allow the entire bulkhead terminal block to be removed and reconfigured. For rapid system reconfiguration, the bulkhead terminal block can be removed and replaced by another pre-wired terminal block. (Extra bulkhead terminal blocks are available as accessories). The bulkhead terminal block also makes the plug-in module compatible with the optional Quick Interconnect Fixture. Refer to the section titled "Installing the Quick Interconnect Fixture" for more information.

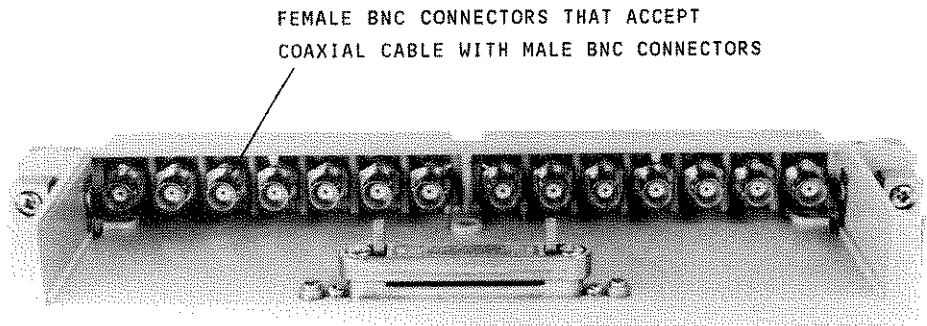

Figure 35. Bulkhead Terminal Block.

Strain Relief

The bulkhead and cable terminal blocks each contain a strain relief clamp. This clamp prevents excessive stress on the cables from damaging the connectors. Route the cables through the clamp as shown in Figure 36 and tighten the screws. The clamp is connected to chassis ground. This means any exposed cable shields that contact the clamp are also grounded.

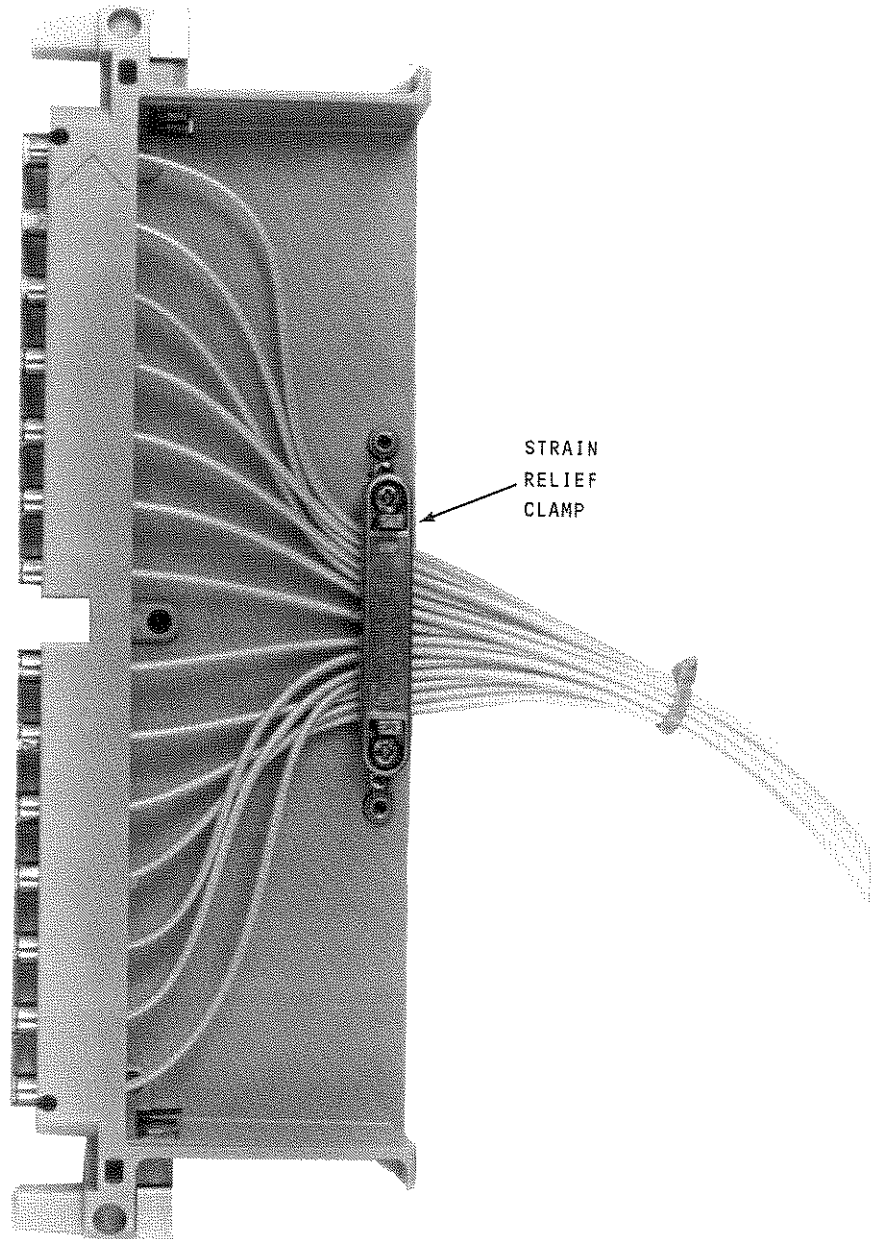

Figure 36. Strain Relief Clamp - Cables.

Terminal Blocks for DIN Plug-In Modules

Plug-in modules that do not have BNC connectors have DIN connectors to which terminal blocks mate for user connections. The terminal blocks can be one of two types. The solder-eye/slide-on terminal block is supplied with DIN modules having an "A" suffix in its model number (e.g. the HP 34502A). The screw terminal block is supplied with modules having a "B" suffix (e.g. the HP 34502B).

Solder-Eye/ Slide-On Terminal Block

The solder-eye/slide-on terminal block is supplied with the "A" suffix modules that have DIN connectors. You can connect field wiring to this terminal block in two ways: 1) Soldering the wires directly to the terminals after wrapping through the solder-eye or 2) Connect slide-on blades (Panduit Part No. DNF18-111FIB-C) to the field wiring and mate them to the slide-on terminals. To simplify the connection of wires by soldering or sliding on terminals, remove the connector from the housing. Remove the two mounting screws that hold the connector to the housing. Wired connectors can be reinstalled by passing them (at an angle) through the rectangular mounting hole from inside the housing. See Figure 32 for an illustration of solder-eye/slide-on terminals.

NOTE

The slide-on blade will accept wire of 22 to 18 AWG. 18 AWG = 1.02 mm diameter, 0.823 mm² cross sectional area; 22 AWG = 0.64 mm diameter, 0.324 mm² cross sectional area.

Screw Terminal Block

The screw-terminal block is supplied with the "B" suffix modules that have DIN connectors. These connectors will accept wire sizes up to 18 AWG. After wires are connected to the terminal block, the silk-screening on the PC board is covered. The labels you installed on the screw-terminal connectors in terminal block preparation help identify the connectors. The A-C-E notation corresponds to the A-C-E designations of the module terminals (see module terminal block label). The next section illustrates a wired terminal block with screw terminal labels.

Strain Relief

The solder-eye/slide-on and screw terminal blocks each contain a strain relief clamp. This clamp prevents excessive stress on the field wiring from damaging the terminals. Route the wires through the clamp as shown in Figure 37 and tighten the screws. The clamp is connected to chassis ground.

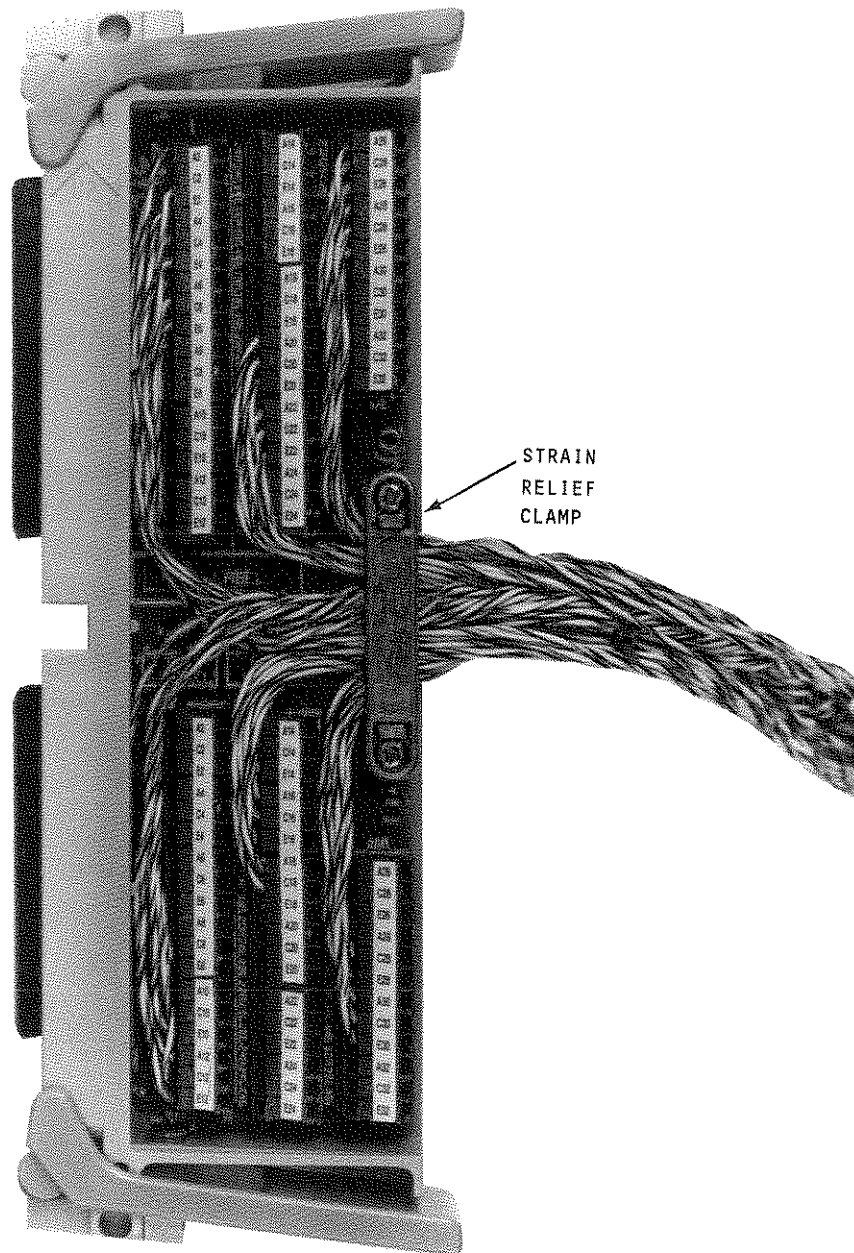

Figure 37. Strain Relief Clamp - Wires.

Connecting Terminal Blocks to Modules

CAUTION

*You can break module connectors if terminal blocks not in a quick interconnect fixture are disconnected without properly using terminal block extractors. **Both top and bottom extractors must be slowly activated together to disengage the connectors.** See the full page caution, Figure 2, at the front of this manual.*

Whether the module has BNC or DIN connectors, the procedure for connecting the terminal blocks to them is the same. The modules should first be installed in the card cage and secured by the upper and lower mounting screws before terminal blocks are connected to them. Figure 38 shows a terminal block being connected to a module. For simultaneous connection of all terminal blocks, you can use a Quick Interconnect Fixture (accessory no. HP 34591A). See the section titled "Installing the Quick Interconnect Fixture" in this manual for information on using this fixture with terminal blocks.

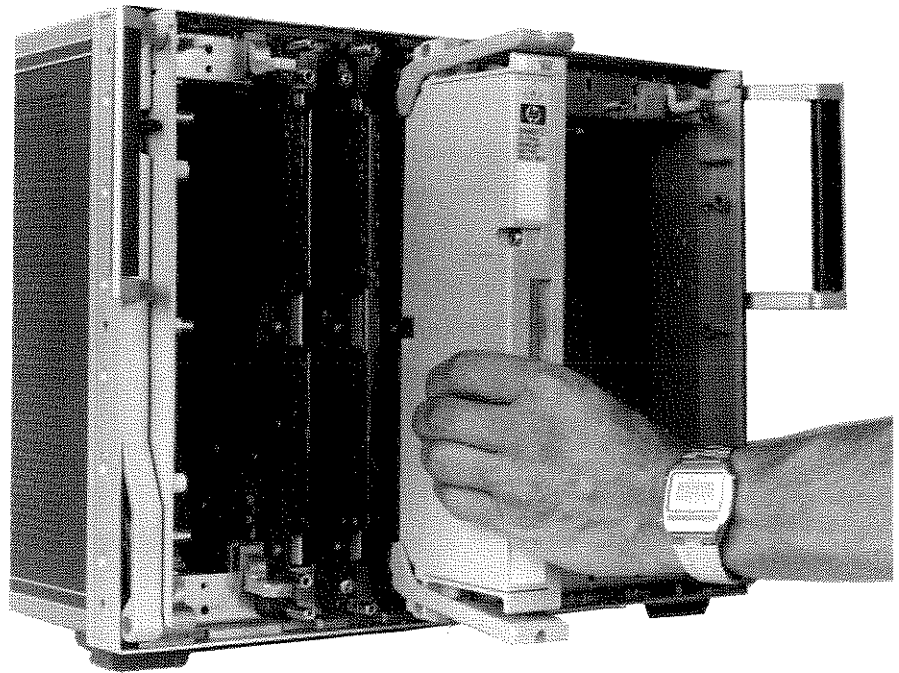

Figure 38. Connecting Terminal Blocks to Modules.

Installing the Quick Interconnect Fixture

The Quick Interconnect Fixture (QIF) is accessory HP 34591 and is used with a quick interconnect mechanism on the user side of the frame (option 590). The QIF can also be used with accessory HP 34592, Wire Distribution Frame. Figure 39 shows a frame with a quick interconnect mechanism, a QIF, and terminal blocks. Accessory HP 34592, Wire Distribution Frame is shown in Figure 56. This section gives you procedures to do the following:

- Install terminal blocks in the QIF
- Mount the QIF on the quick interconnect mechanism
- Operate the mechanism to engage the fixture to the module connectors
- Build DUT fixtures that can be installed on a QIF

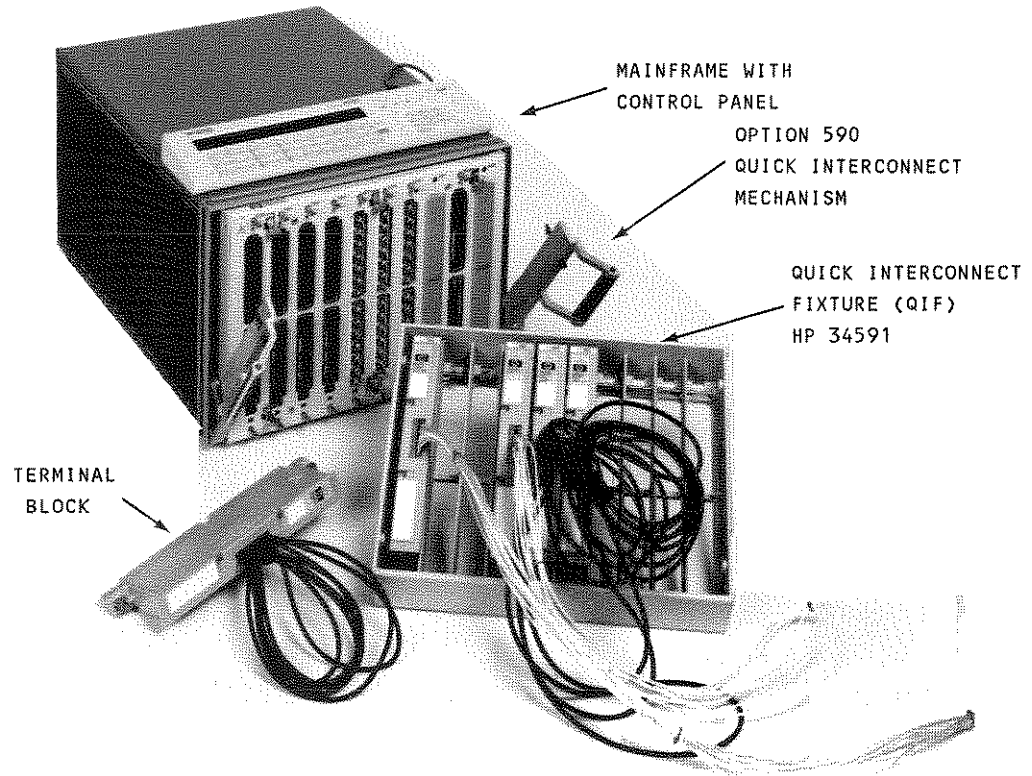

Figure 39. QIF and Mechanism.

Quick Interconnect Fixture

Figure 40 shows the parts of the Quick Interconnect Fixture.

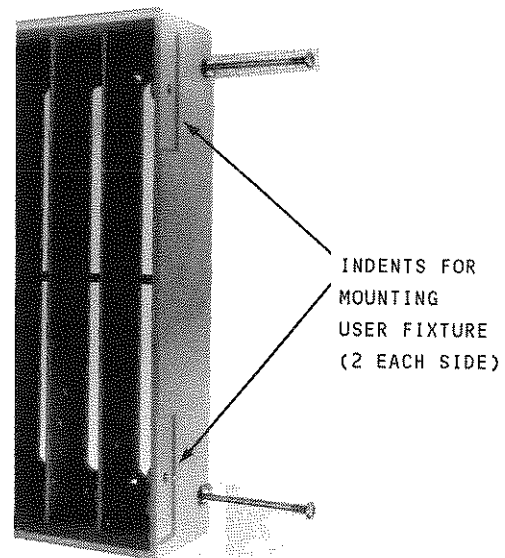
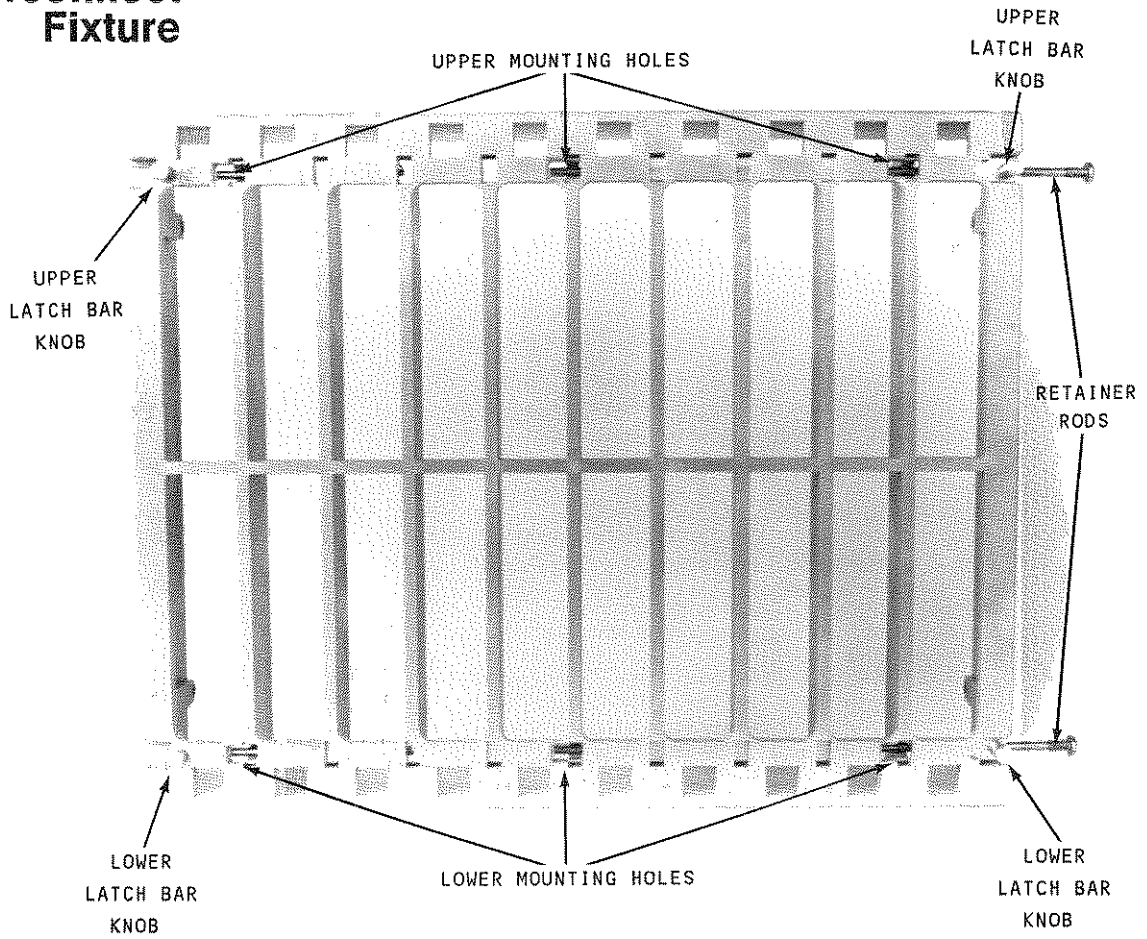

Figure 40. Quick Interconnect Fixture.

Installing Terminal Blocks

Refer to Figure 41 for installing terminal blocks.

1. Remove terminal block extractors as described in "Terminal Block Preparation".
2. Remove retainer rods.
3. Hold QIF at an angle and load terminal blocks (warning faces left) in slot position that the module is in. Slot numbers are on the QIF label.
4. Verify that all terminal blocks are fully seated in the QIF (all should be at the same height).

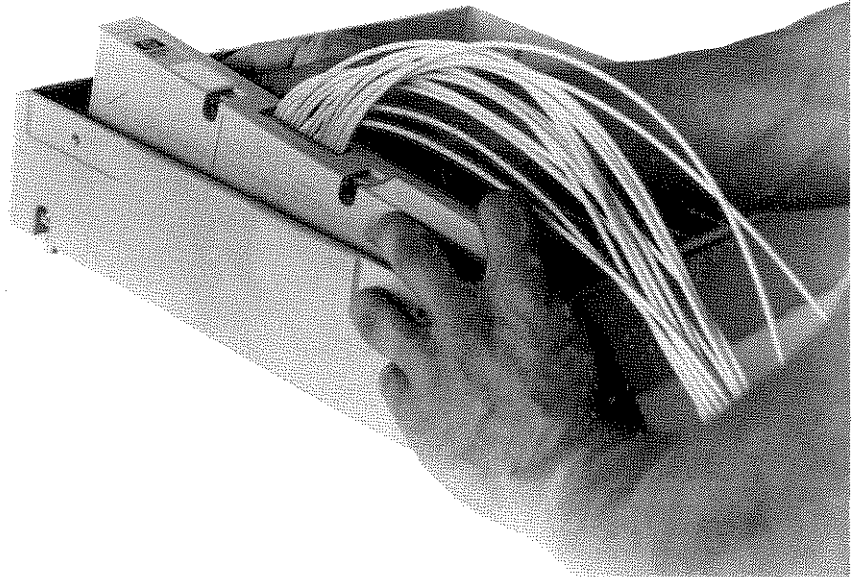

Figure 41. Installing Terminal Blocks.

Installing Retainer Rods

Refer to Figure 42 for installing retainer rods.

1. Push retainer rods through QIF and all terminal blocks.
2. Screw retainer rod into QIF until it is snug.
3. Verify each terminal block is captured at both ends by the retainer rods.

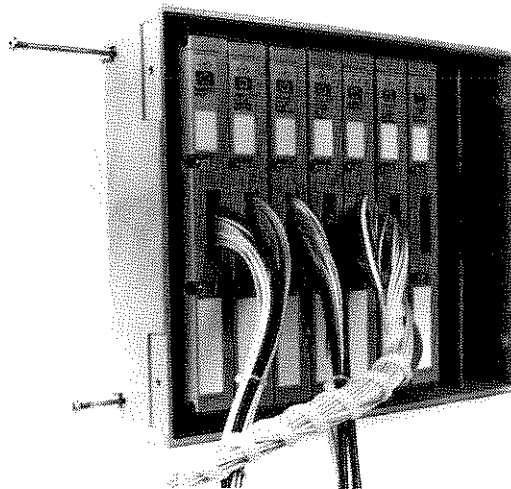

Figure 42. Installing Retainer Rods.

Unlock QIF Mechanism Handles

Refer to Figure 43 to unlock the QIF mechanism handles.

1. Press down on the handle locks (one on each handle) to unlock the QIF mechanism handles. Lower both handles together (three upper and three lower mounting bars move out).

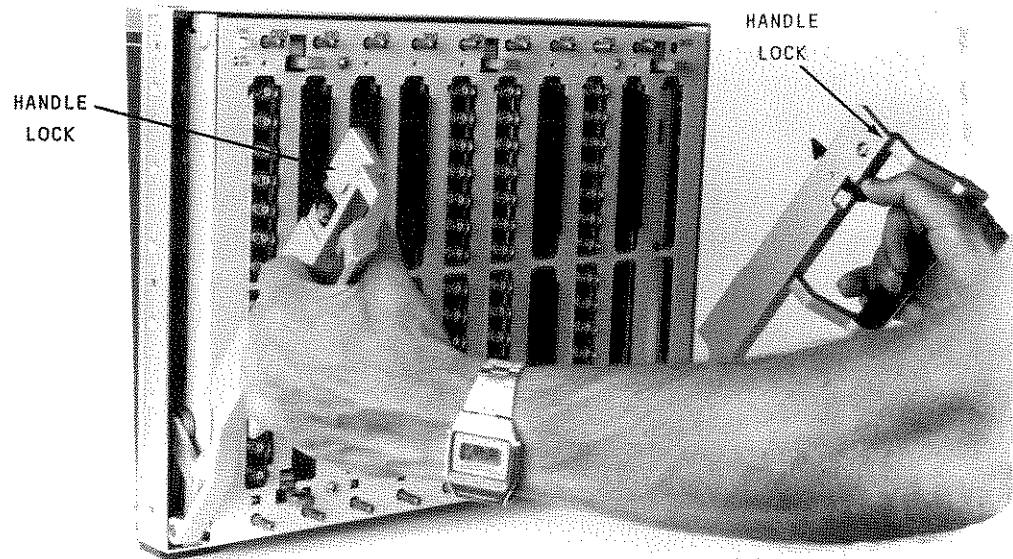

Figure 43. Unlock QIF Mechanism Handles.

Installing Loaded Fixture Onto Mounting Bars

Refer to Figure 44 to install a loaded fixture onto mounting bars.

1. Push upper and lower latch bars to the unlocked position (full left).
2. Line up the QIF with the three upper and lower mounting bars (three black triangles appear on the QIF where the fixture meets these bars).
3. Set the bottom of the QIF on the bottom mounting bars first as shown in Figure 44.

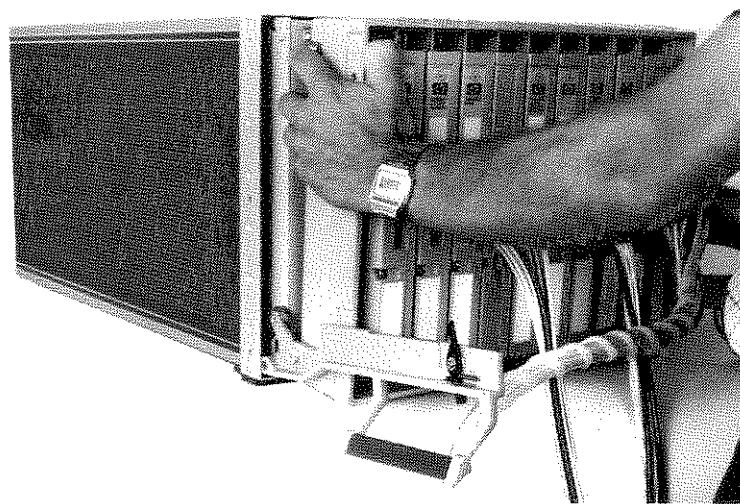

Figure 44. Installing Loaded Fixture Onto Mounting Bars.

Locking QIF to Mounting Bars

Refer to Figure 45 to lock the QIF to the mounting bars.

1. Set the QIF on the mounting bars and lock the upper latch bar first (push upper latch bar knob full right).
2. Lock the lower latch bar (push lower latch bar knob full right).

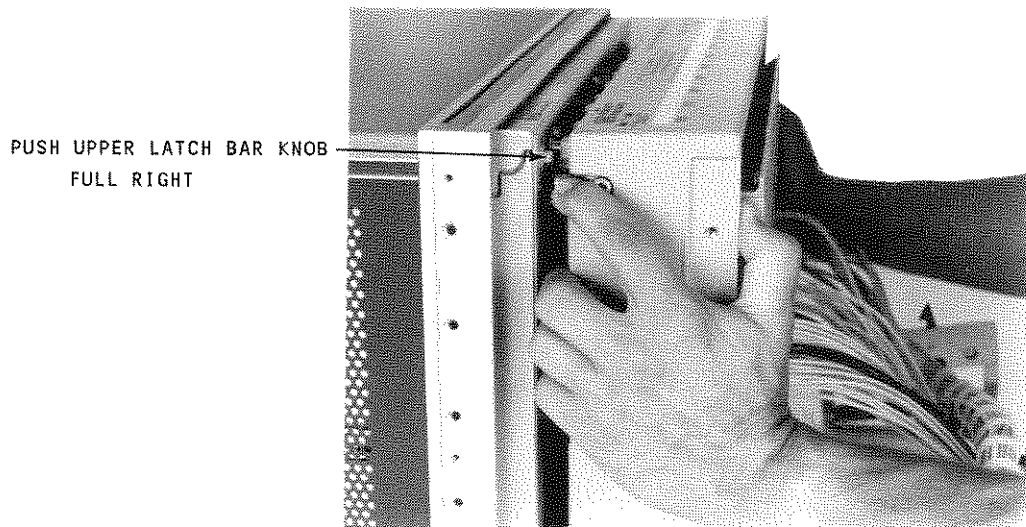

Figure 45. Locking QIF to Mounting Bars.

Engaging QIF and Locking Handles

Refer to Figure 46 to engage the QIF and lock the handles.

1. Slowly rotate the QIF mechanism handles upward to the locked position (the QIF will move inward and engage with the module connectors). Carefully monitor the first mating to make sure all terminal blocks are installed correctly and no connector damage results.

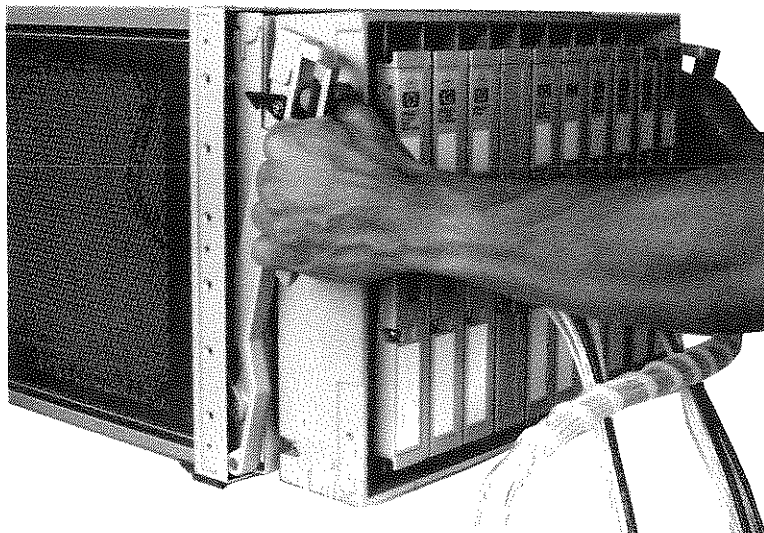

Figure 46. Engaging QIF and Locking Handles.

Removing the QIF

To remove the QIF, always unlock the lower latch bar first by pushing the lower latch bar knob left. The weight of the fixture, terminal blocks, and field wiring cause the fixture to tip toward you if the upper latch bar is unlocked first. After unlocking the lower latch bar, unlock the upper latch bar (push upper latch bar knob left). Your hands are in position to hold the weight of the fixture.

Typical QIF Installation

Figure 47 shows a typical standard rack mounted installation of an option 590 HP 3235 with a fully loaded Quick Interconnect Fixture (QIF) installed.

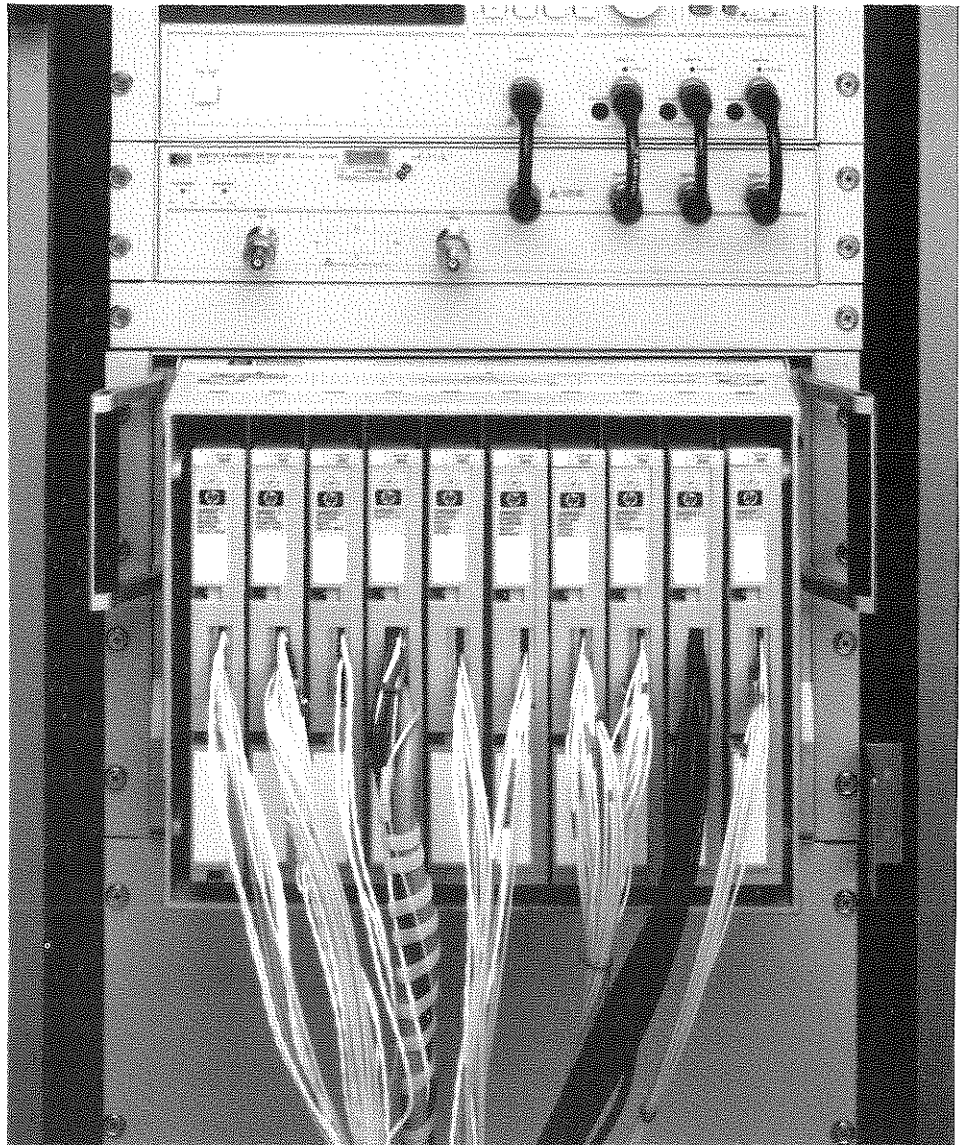

Figure 47. Typical HP 3235 Rack Installation With QIF.

Installing User-Built DUT Fixtures

The QIF has two rectangular indents on each side (see Figure 40) with threaded inserts for mounting a user-built DUT fixture. The inserts accept an M4 x 0.7 x 8 screw. A flathead screw is recommended to allow maximum clearance for the mechanism handles when they are pulled down. Figure 48 shows a typical fixture installed on the QIF. A sheetmetal layout for a fixture you can build and customize for your specific needs is shown in Figure 49. This fixture can be purchased (HP P/N 03235-04111 Quick Interconnect Fixture Cover) to cover the terminal blocks loaded in a QIF. You can make a DUT fixture out of this cover by making the required cable/wiring cutout and mounting a DUT connector over the hole. Cable/wiring between DUT connector and terminal blocks in the QIF is routed through the cut out.

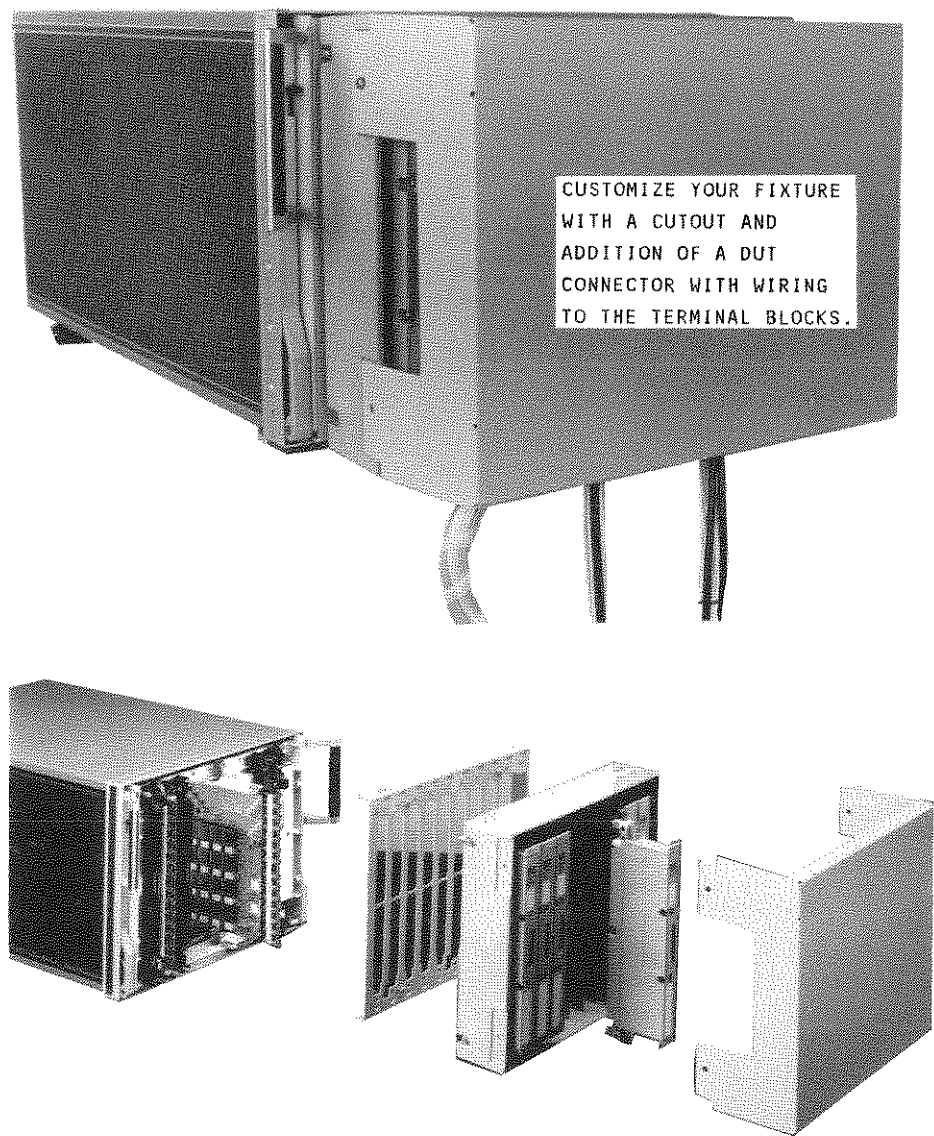

Figure 48. Typical User-Built Fixture on QIF.

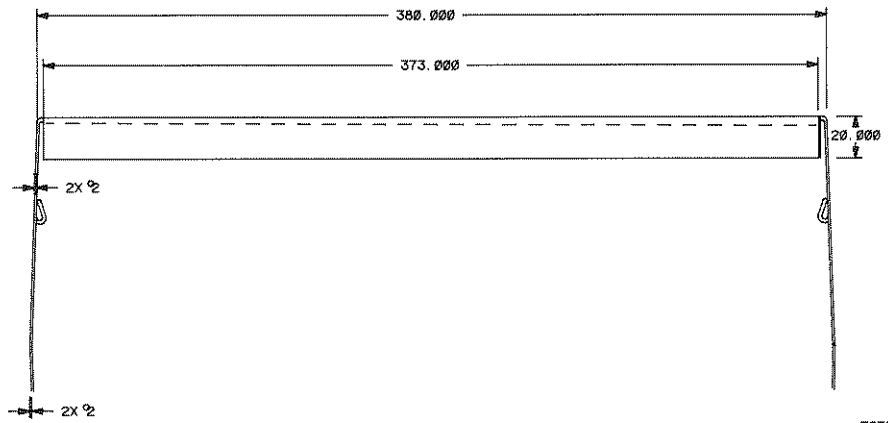
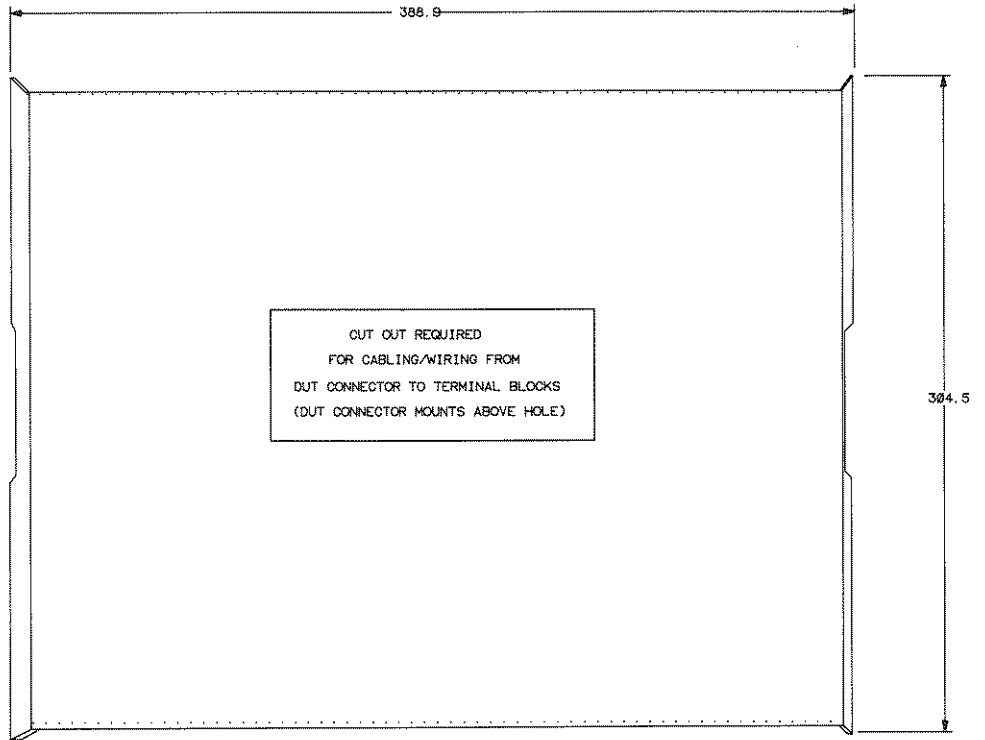

Figure 49. Sheetmetal Layout for User-Built Fixture.

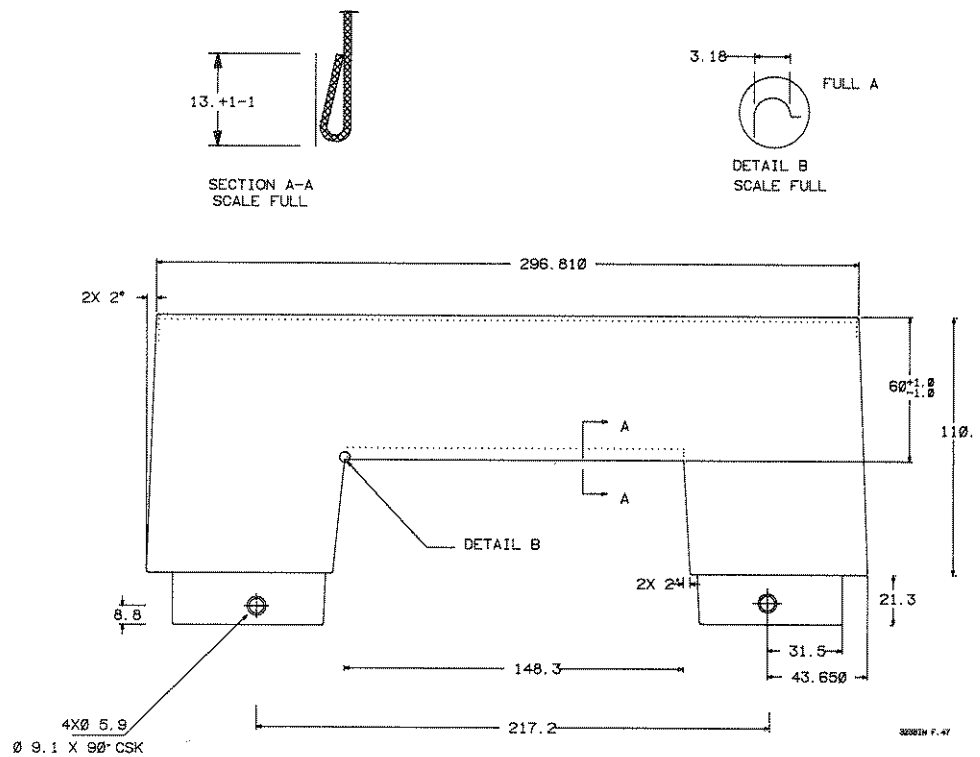

Figure 49 continued. Sheetmetal Layout for User-Built Fixture.

Benchtop or Rack Mount?

Your HP 3235 mainframe or extender can be used on the bench or rack mounted. You can rack mount the frame with either the system side or user side facing the front of the rack. Option 908 provides two rack mount kits for mounting the mainframe or extender in a 19 inch wide EIA rack. Provided are a standard rack mount kit (HP P/N 5061-9681) for mounting the user side to the front of the rack and a reverse rack mount kit (HP P/N 03235-80800) for mounting the system side facing the front of the rack. Instructions for installing the reverse rack mount kit are contained in the section titled "Reverse Rack Mounting". The standard rack mount kit has instructions included with it.

NOTE

If you are rack mounting the HP 3235, we recommend that you not restrict access to the rear of the rack. If service is required of modules at the back of the rack where access is restricted, your test system cabling and the need to remove the HP 3235 from the rack for service will increase the down time.

Bench Operation

If a mainframe or extender is used on the bench, you must allow for air clearance around the front, back, and sides of the frame. At least two inches (50mm) of clearance must be allowed at the system side of the frame, and one inch (25 mm) of clearance at the user side and frame sides. The fan pressurizes the cavity at the bottom of the frame and forces air through air holes at the bottom of each plug-in module and system side assembly. Air is exhausted through the front, back, and sides. Restricting the air flow by not allowing adequate clearance can cause excessive temperature inside the frame. Excessive temperature reduces reliability of both the system assemblies and plug-in modules. Your HP 3235 is equipped with feet and tilt stand in place, ready for bench operation.

Standard Rack Mounting

HP P/N 5061-9681 is the standard rack mount kit used to mount a mainframe or extender with the user side (the card cage) facing the front of a 19 inch EIA rack. Installation instructions are included with the rack mount kit. You can use this kit with a frame containing a quick interconnect mechanism and QIF. For further information on HP rack mounting kits, contact your nearest HP Sales and Service Office.

Reverse Rack Mounting

HP P/N 03235-80800 is the reverse rack mount kit for mounting the mainframe or extender with the system side facing the front of a 19 inch EIA rack. This will allow all field wiring to be routed into the rear of the rack where connections can be made directly to the terminal blocks on the user side. A frame containing a quick interconnect mechanism cannot be reverse rack mounted. Installation instructions for installing the reverse rack mount kit follow.

Table 5. Reverse Rack Mount Kit Parts List.

HP Part Number 03235-80800

--CONTENTS--

<u>QTY</u>	<u>DESCRIPTION</u>	<u>PART NO.</u>
2	Reverse Rack Mount Flanges	03235-01210
2	Reverse Rack Mount Rails	03235-01211
6	M4.0 x 0.7 10mm Screw, Pan Head	0515-1114
8	Sheetmetal Nut, 0.5W, 10-32	0590-0804
8	10-32 5/8 Screw, Flathead	2680-0106
8	Cupped Washer, Nickel Plated	3050-0007
8	Finish Washer, Nylon	3050-0248

NOTE

You cannot reverse rack mount a mainframe or extender that has option 590 (Quick Interconnect Mechanism). The mechanism handles do not allow reverse rack mount flanges to be mounted.

1. Remove standard rails from rack and install the reverse rack mount rails with the same hardware (1/4 inch bolts with nuts). The rails are universal and can be used on either side of the rack.
2. Refer to Figure 50. Remove the side trim from the frame bezel.
3. Attach the reverse rack mount flanges with three pan head screws in each flange. Refer to Figure 51 to determine which set of mounting holes to use. One set of holes provides more space in the rack at the system side of the STU. Flanges can be used on either side.
4. Remove the four feet and all user-side plug-in modules from the frame (to reduce weight). Use two people to install the HP 3235 into the rack due to its size and weight. Lift the HP 3235 and slide it onto the rails from the rear of the rack. Slide until the rack mount flanges on the HP 3235 are flush with the rear of the rack (bezel drops into rail slots).
5. Mark the rack holes through at least three flange holes that line up with each other (there is hardware for four holes on each side).
6. Remove the HP 3235 from the rack and install the sheetmetal nuts in the marked locations. See Figure 52.
7. Reinstall the HP 3235 as in step 4.
8. Install flathead screws with cupped washers and finish washers through the flanges and into the sheetmetal nuts installed on the rack. Your HP 3235 is now reverse rack mounted.

Benchtop or Rack Mount?

Your HP 3235 mainframe or extender can be used as a benchtop instrument or it can be mounted in a 19-inch EIA cabinet. You can mount the HP 3235 with either the system side or the user side facing the front of the rack cabinet. Option 908 for the HP 3235 or HP 3235E includes rack flanges, support rails, and other hardware for mounting the frame in the forward or reverse position. (Option 908 can be ordered stand-alone as HP part number 03235-80908.) Installation instructions for forward rack mounting are included with the forward rack mount kit. The following section titled "Reverse Rack Mounting" contains installation instructions for reverse rack mounting.

NOTE

When rack mounting the HP 3235, we recommend that you don't restrict access to the rear of the rack cabinet. If service is required on modules (either user modules or system modules) at the back of the rack, your test system cabling and the need to remove the HP 3235 from the rack for service will increase the system downtime.

Bench Operation

If the HP 3235 is to be used as a benchtop instrument, you must leave space around the front, back, and sides of the frame for air circulation. The HP 3235's internal fan pressurizes the frame cavity and circulates air through holes below each user side and system side module. Air is exhausted from the front, back, and sides of the frame. Restricting air flow by not allowing adequate clearance can cause an excessive temperature rise within the mainframe. At least two inches (50mm) of clearance must be allowed on the system side of the frame. At least one inch (25 mm) of clearance must be allowed on the front and sides of the frame.

Forward Rack Mounting

The forward rack mounting kit places the HP 3235 with the user side facing the front of the rack cabinet. Installation instructions are included with the forward rack mount kit. The forward rack mount kit (HP part number 5061-9681) is included with HP 3235 Option 908. The forward rack mount kit may also be used to mount a frame containing a Quick Interconnect mechanism (HP 3235 Option 590).

Reverse Rack Mounting

The reverse rack mounting kit places the HP 3235 with the system side facing the front of the rack cabinet. This allows all field wiring to be routed into the rear of the rack where connections are made directly to the plug-in module terminal blocks. A frame containing a Quick Interconnect mechanism (HP 3235 Option 590) CANNOT be reverse rack mounted since the QIF mechanism handles do not allow the reverse mount flanges to be installed.

Table 5 shows the hardware which is included with HP 3235 Option 908 to reverse mount the HP 3235 frame. The instructions for installing the reverse rack mount kit follow Table 5.

C

C

C

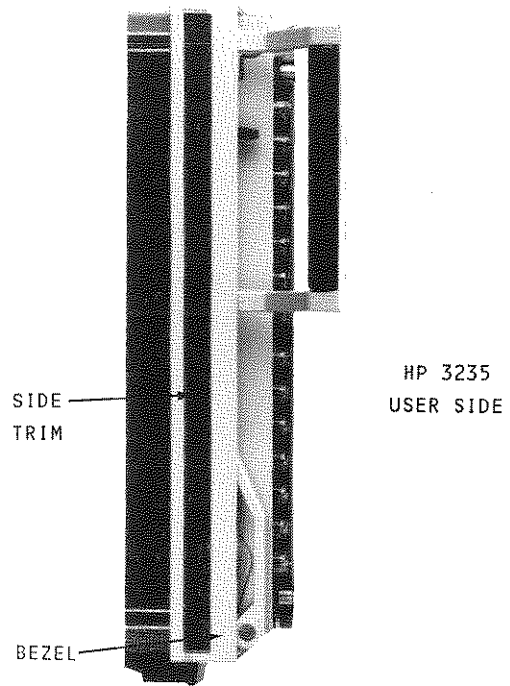

Figure 50. Remove Side Trim From Bezel.

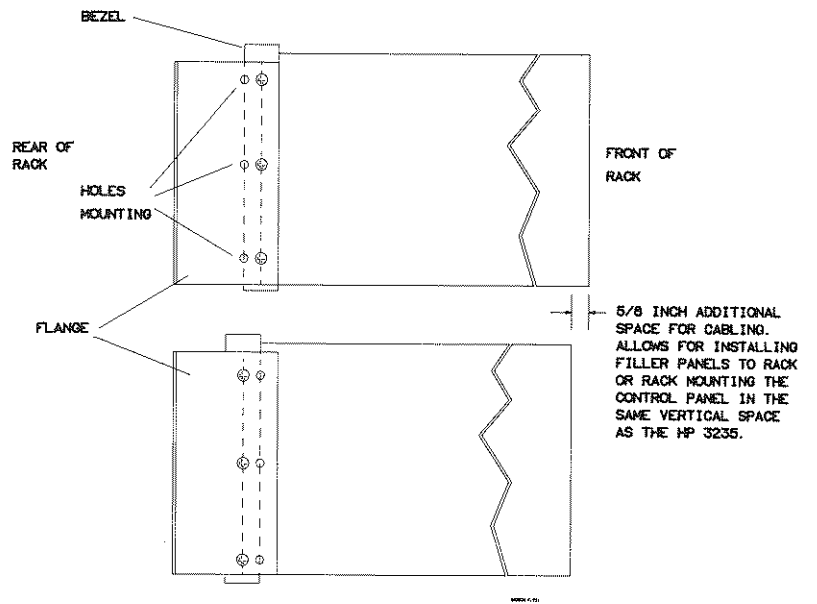
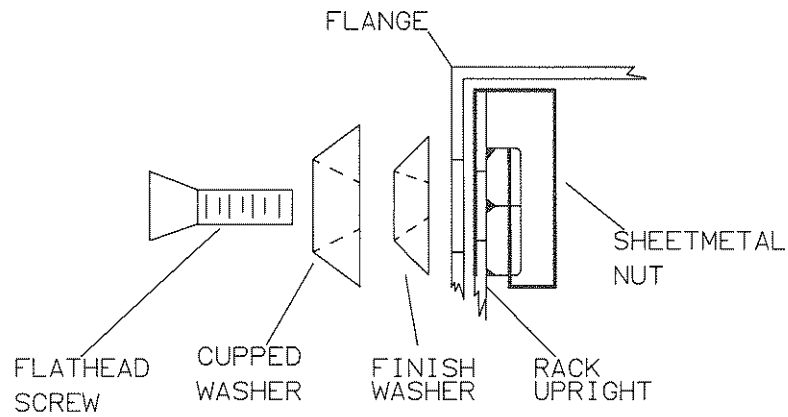

Figure 51. Reverse Rack Mount Flange Mounting Holes.



3235IN F.22;

Figure 52. Installing Sheetmetal Nuts and Hardware.

Rack Slides

You can equip a front mounted HP 3235 with rack slides which also mount to the equipment rack. The slides extend out with the instrument and support it as the HP 3235 is removed from the rack. Rack slides for the HP 3235 are HP Part No. 1494-0016. To install the rack slides on an HP 3235, you must replace the two standard side panels with recessed panels (HP Part No. 5060-9958).

Installing the HP 34550A Control Panel

The HP 34550A Control Panel is an accessory for the HP 3235 STU. If you ordered and received a control panel, you have three ways of using it:

1. Benchtop use
2. Rack mount slanted (requires 3.5 inches of vertical rack space)
3. Rack mount vertical (requires 5.5 inches of vertical rack space)

NOTE: Accessory HP 34551A, Control Panel Rack Kit, contains both the slanted and vertical rack mount panels.

In all three cases, the Control Panel cable plugs into the CONTROL PANEL connector in the CONTROLLER INTERFACE section of the system side of the STU as shown in Figure 9. At power-on, the Control Panel display indicates the steps in the power-on sequence. The sequence takes about 10 seconds to complete. During the power-on sequence, the display shows "Testing ROM", "Testing RAM", "# Modules Found", and "READY" when the sequence is complete.

Benchtop Use

To use the Control Panel on the benchtop, simply plug the Control Panel cable into the connector labeled CONTROL PANEL on the system side of the STU.

Rack Mount Slanted

To rack mount the Control Panel slanted, you will need the slanted rack mount panel which is part of HP 34551A. 3.5 inches of vertical rack space is required. You secure the Control Panel to this rack mount panel and mount it to the rack.

Refer to Figure 53 to rack mount the HP 34550A Control Panel slanted.

1. Set the Control Panel on the slanted mounting panel. The mounting panel has two captive screws in the bottom support which screw into the Control Panel to secure it to the panel.
2. Screw the two captive screws into the Control Panel with a no. 2 pozidriv screwdriver.
3. Route the 6.56 foot (2 metre) Control Panel cable through space between instruments in the rack to the system side of the HP 3235 and plug it into the CONTROL PANEL connector. Begin routing the cable from the rack location you have chosen for mounting the Control Panel.
4. Install the rack mount panel with Control Panel mounted to it in the 3.5 inch rack location you have chosen.

NOTE

Mounting the Control Panel slanted in a rack will not allow a standard door to be closed on the rack. Vertically mounting the Control Panel will allow a standard door to be closed on the rack.

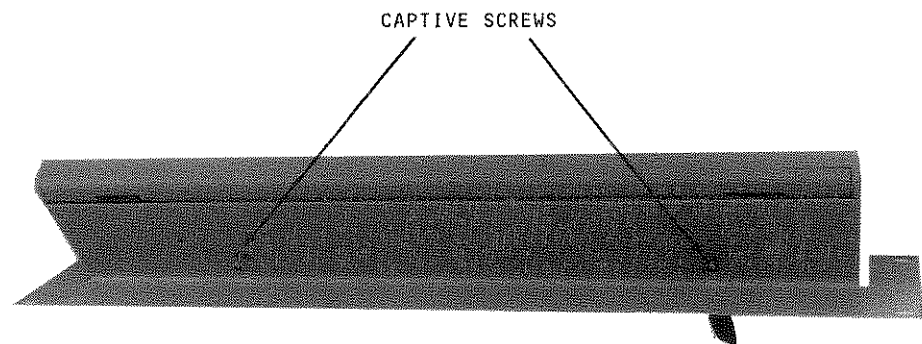

Figure 53. Slanted Control Panel Rack Mount.

Rack Mount Vertical

To rack mount the Control Panel vertically, you need the vertical rack mount panel which is part of HP 34551A. You secure the Control Panel to this rack mount panel and mount it to the rack.

Refer to Figure 54 to vertically rack mount the Control Panel.

1. Pass the Control Panel cable through the hole on the right, top of the rack mount panel. The cable is 6.56 feet long (2 metres).
2. Position the Control Panel on the rack mounting panel. This panel has two captive screws which secure the Control Panel to it.
3. Screw the two captive screws into the Control Panel using a no. 2 Pozidriv screwdriver.
4. Route the Control Panel cable through the space between instruments in the rack. Start from the point where the Control Panel will be mounted in the rack and route to the system side of the HP 3235. Plug the cable into the HP 3235.

5. Install the rack mount panel with Control Panel secured to it in the 5.5 inch rack location you have chosen.

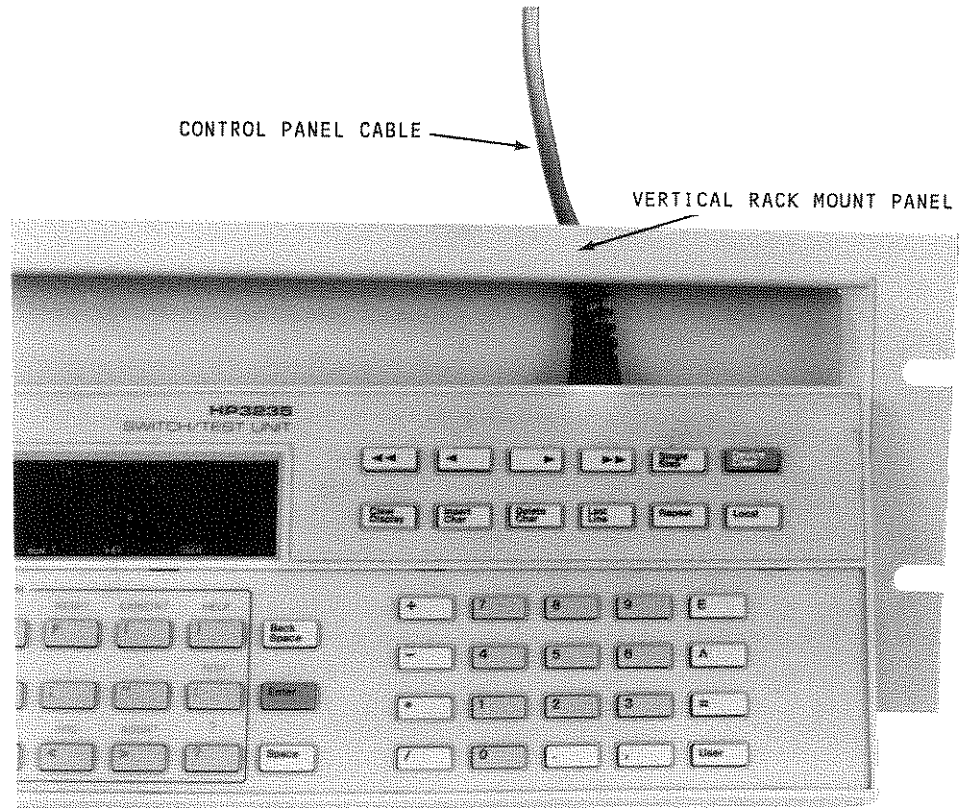

Figure 54. Vertical Panel Rack Mount.

Miscellaneous

Trigger Bus

Two BNC connectors in the lower left corner of the system side of the HP 3235 provide connections to the internal trigger bus system. These connectors are in the CROSSGUARD section and are labeled EXT TRIG (IN and OUT). See Figure 1. The trigger bus (TB) system is used to synchronize events among the plug-in modules and your external test system. Information on using the TB system is provided in Chapter 9, Trigger Buses and System Timing, in the HP 3235 Programming and Systems Information Manual.

Connecting to the Interlock Switch

You can externally sense the opening of the quick interconnect mechanism handles on a mainframe. However, the mainframe processor will not sense the opening of an extender quick interconnect mechanism. A two-contact connector is present inside the system side access compartment of the mainframe. See Figure 55. These contacts close when the mainframe mechanism handles are released from the locked position. More information on using these contacts is contained in Chapter 2, "Connecting to the Interlock Switch", in the Programming and System Information Manual.

The connector in the access compartment has male terminals. You will need the following connector parts, with your external wiring, to mate to this connector.

1. Connector housing: HP P/N 1251-2505 (Molex 03-09-1022).
2. Female terminals, 2 each: HP P/N 1251-2600 (Molex 02-09-1116) accepts wire sizes of 22-18 AWG. 18 AWG = 1.02 mm wire diameter, 0.833 mm² cross sectional area; 22 AWG = 0.64 mm wire diameter, 0.324 mm² cross sectional area.

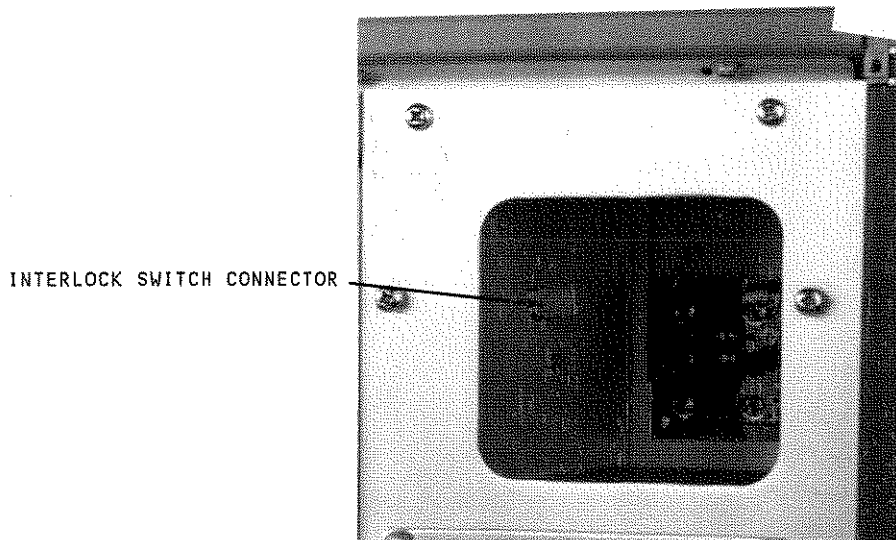

Figure 55. Interlock Contact Connector.

Installing the HP 34592A Wire Distribution Frame

The HP 34592A is a standalone quick interconnect mechanism which holds ten feedthrough panels. This provides a central wiring center for non-switched signals. Figure 56 illustrates a Wire Distribution Frame with a Low-Frequency Feedthrough Panel installed. The Wire Distribution Frame mounts in a 19 inch EIA rack. You rack mount the Wire Distribution Frame using the standard rack mounting kit 5061-9681. Installation instructions are included in the rack mount kit.

To load the Wire Distribution Frame, refer to the section titled "Installing Feedthrough Panels". Refer to the section titled "Installing the Quick Interconnect Fixture" for connecting terminal blocks in a fixture to the modules.

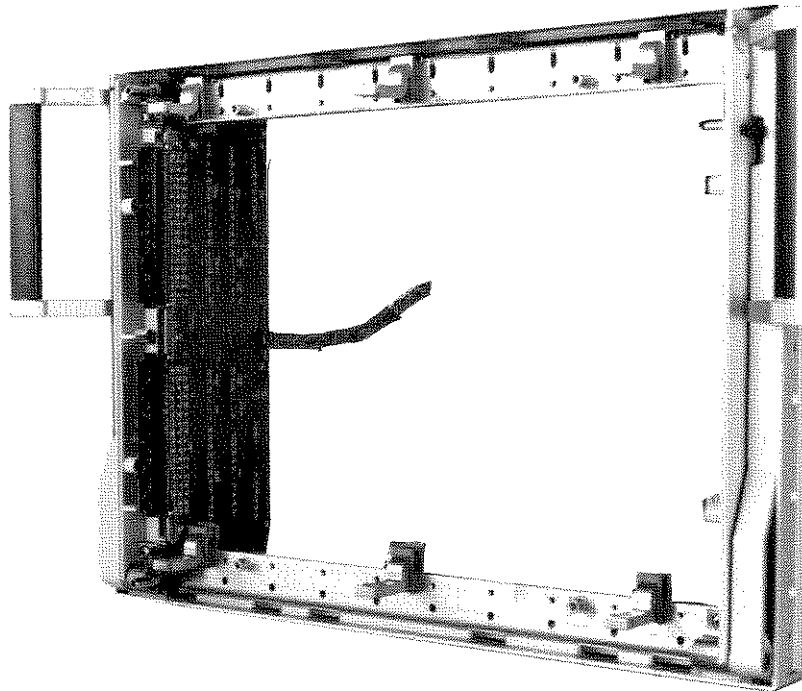

Figure 56. Wire Distribution Frame.



